

# *FEL based Four Wave Mixing*

C. Masciovecchio

Elettra-Sincrotrone Trieste, Basovizza, Trieste I-34149



- **Introduction to FERMI Free Electron Laser**
- **FERMI End Stations**
- **EIS program (TIMEX & TIMER)**
- **MULTICOLOR Spectroscopy**



# Why Free Electron Lasers ?

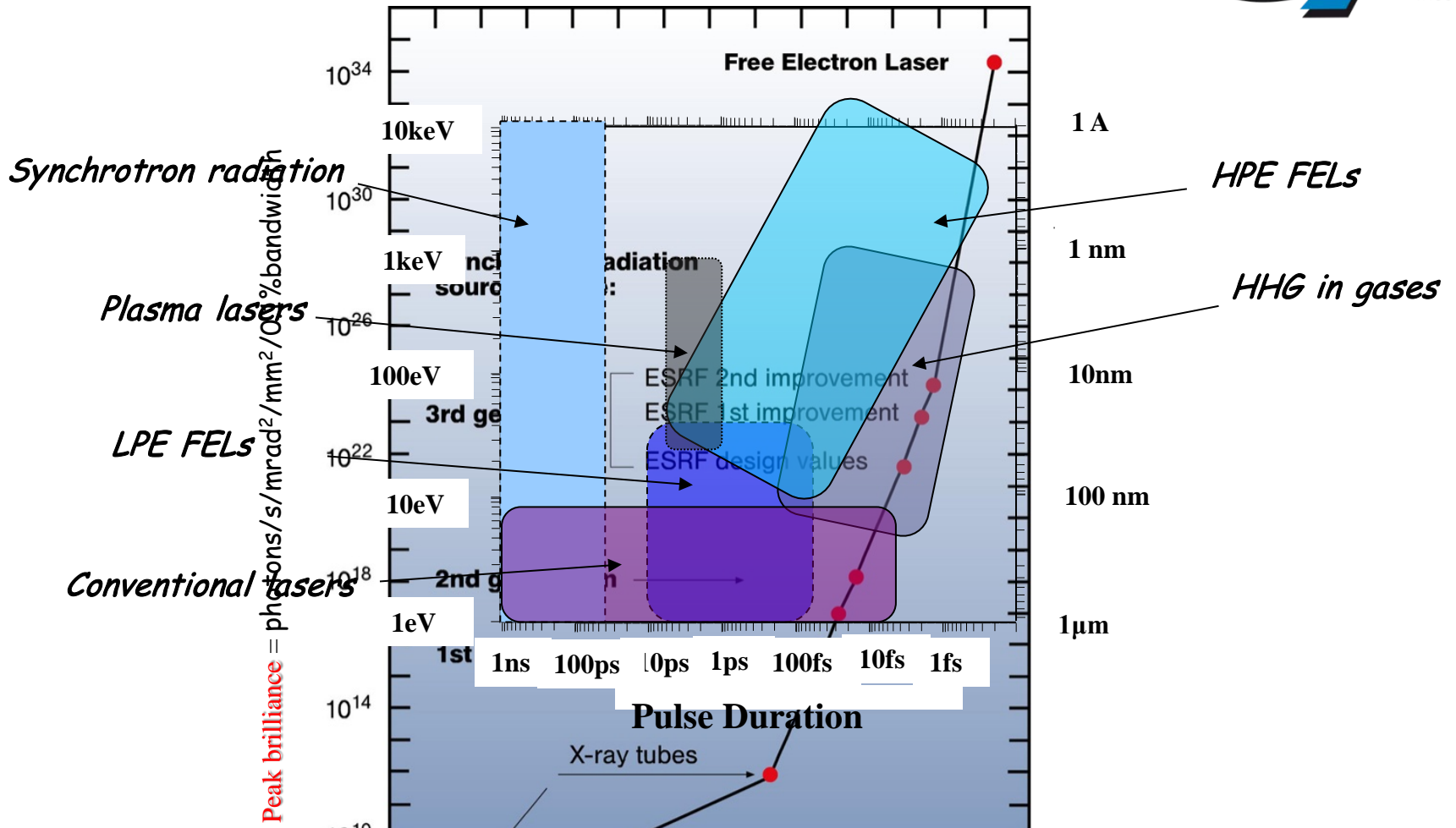

**Imaging** with high Spatial Resolution ( $\sim \lambda$ ): fixed target imaging, particle injection imaging,...

**Dynamics:** four wave mixing (nanoscale), warm dense matter, extreme condition, ....

**Resonant** Experiments: XANES (tunability), XMCD (polarization), chemical mapping, .....

# SASE vs Seeded

(a)

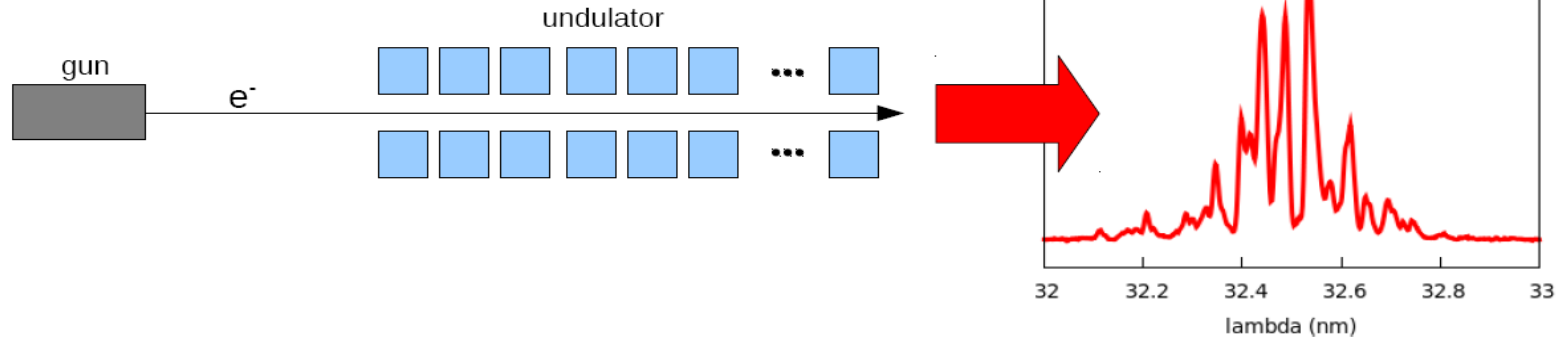

(b)

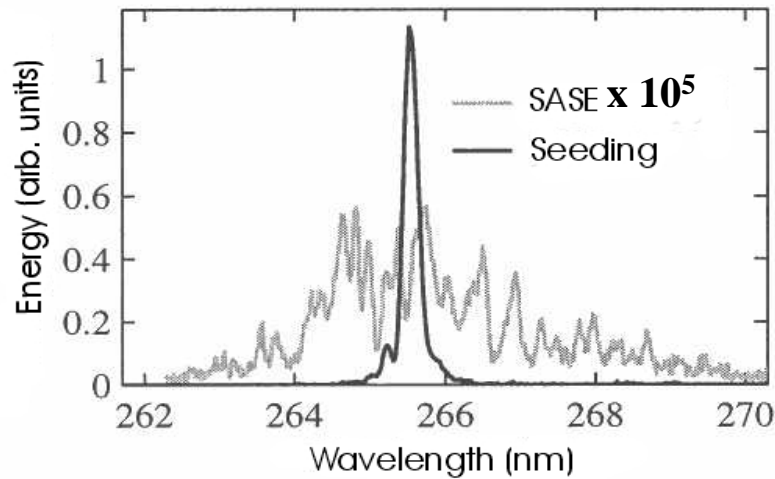
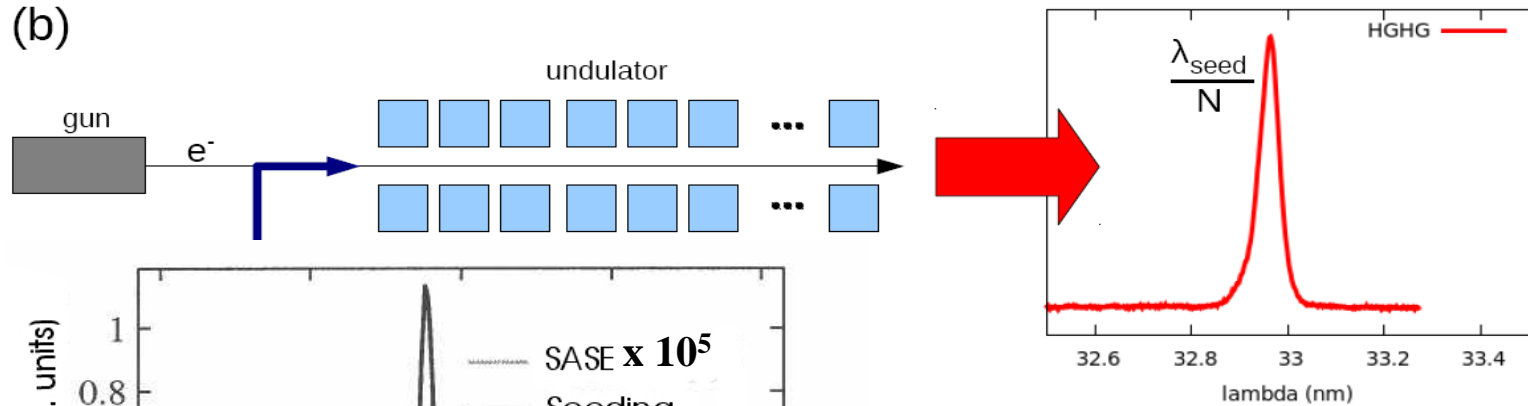

*F. Bencivenga et al., Adv. In Phys. (2015)*

*L. H. Yu et al., PRL (2003)*

# The FERMI Free Electron Laser

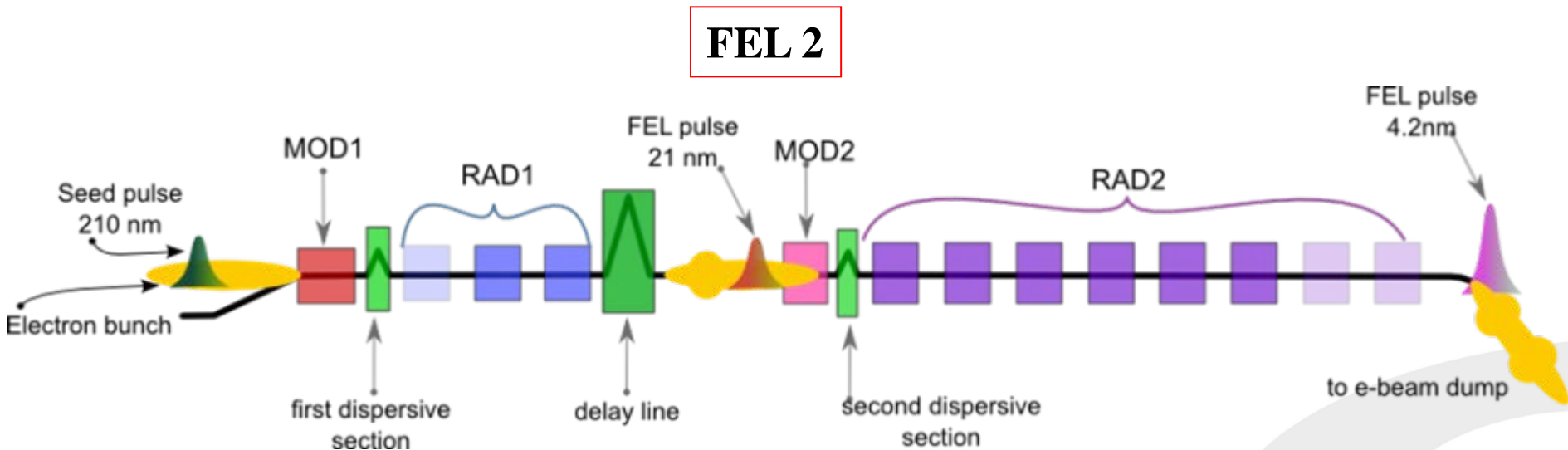
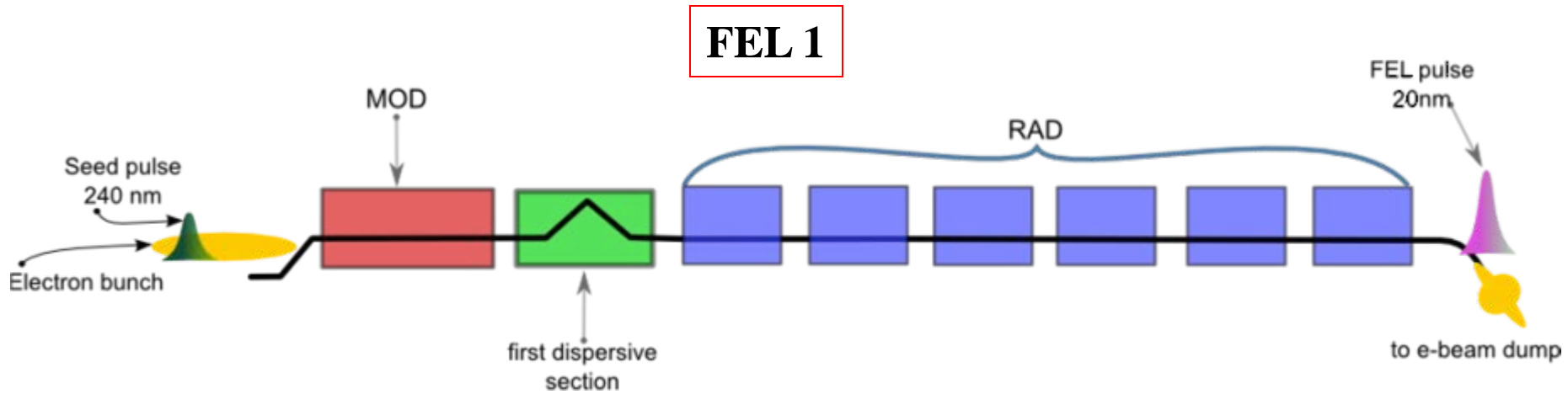

# Highly coherent and stable pulses from the FERMI seeded free-electron laser in the extreme ultraviolet

*E. Allaria et al., Nat. Phot. (2012)*

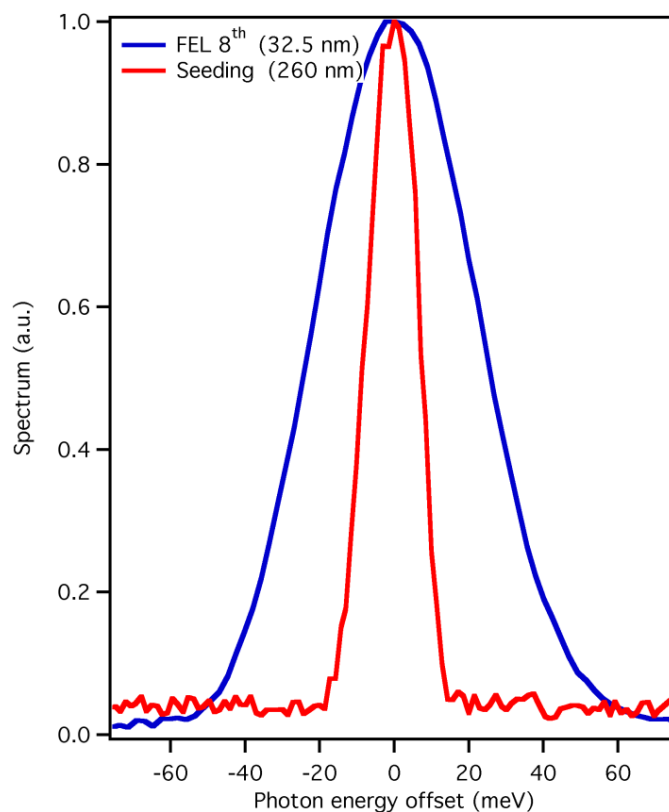
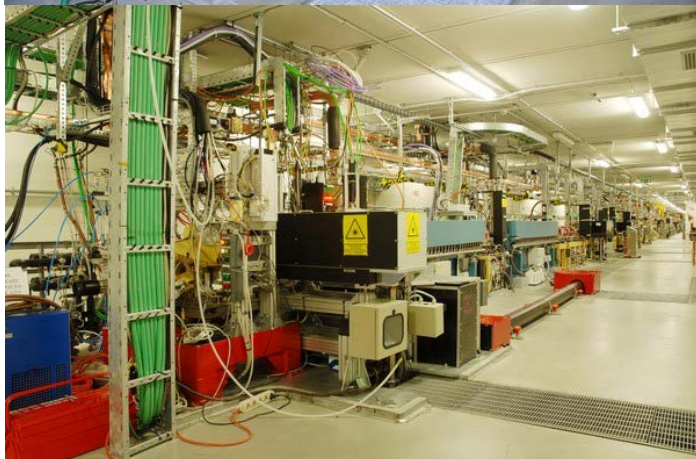

$\Delta t < 100$  fs  
Flux  $\sim 10^{13}$  ph/pulse  
 $E \sim 10 - 500$  eV  
**Total Control** on  
Pulse Energy  
Time Shape  
Polarization

# Two-stage seeded soft-X-ray free-electron laser

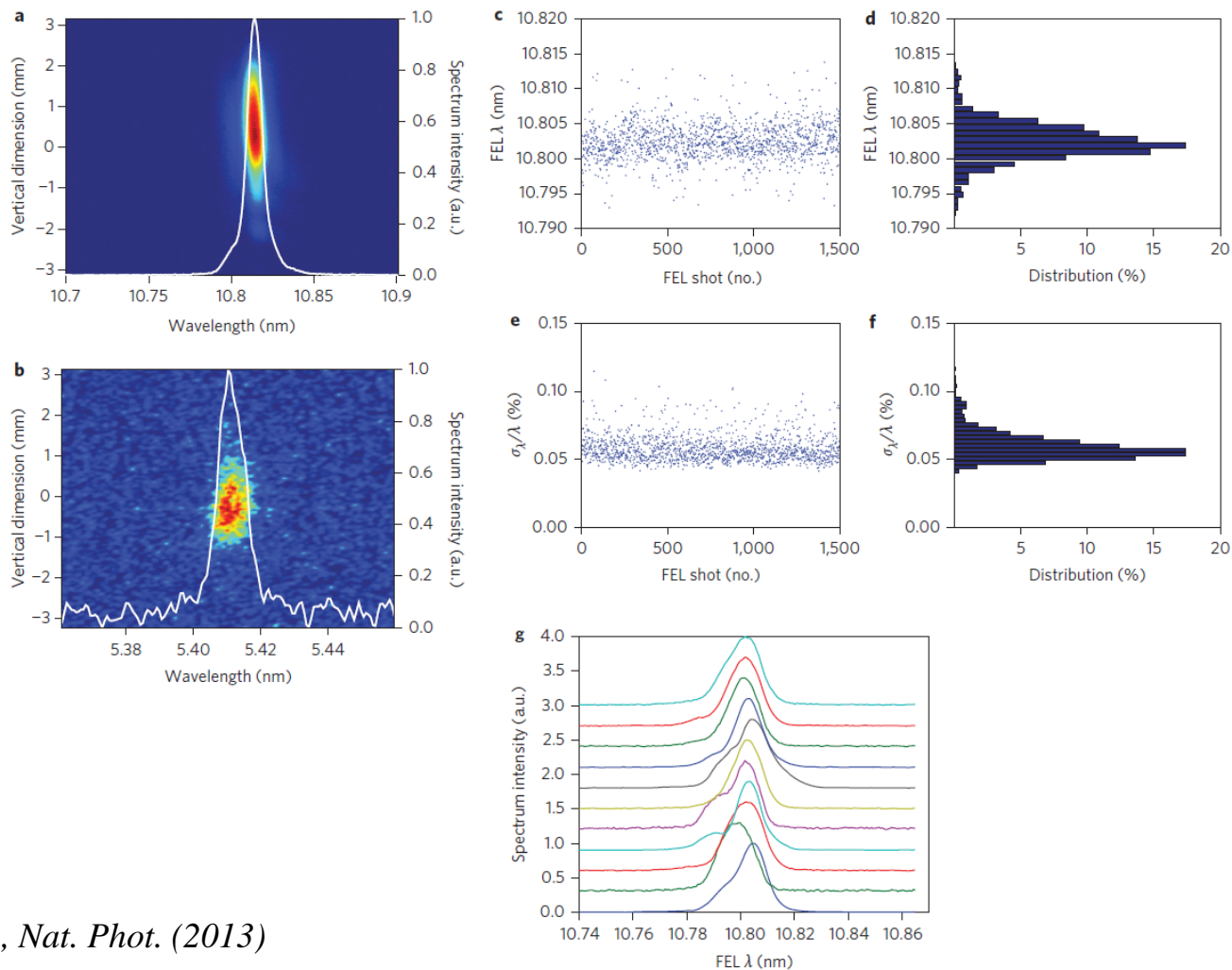

*E. Allaria et al., Nat. Phot. (2013)*

## EIS (Elastic & Inelastic Scattering)

C. Masciovecchio et al., *J. Synch. Rad.* (2015)

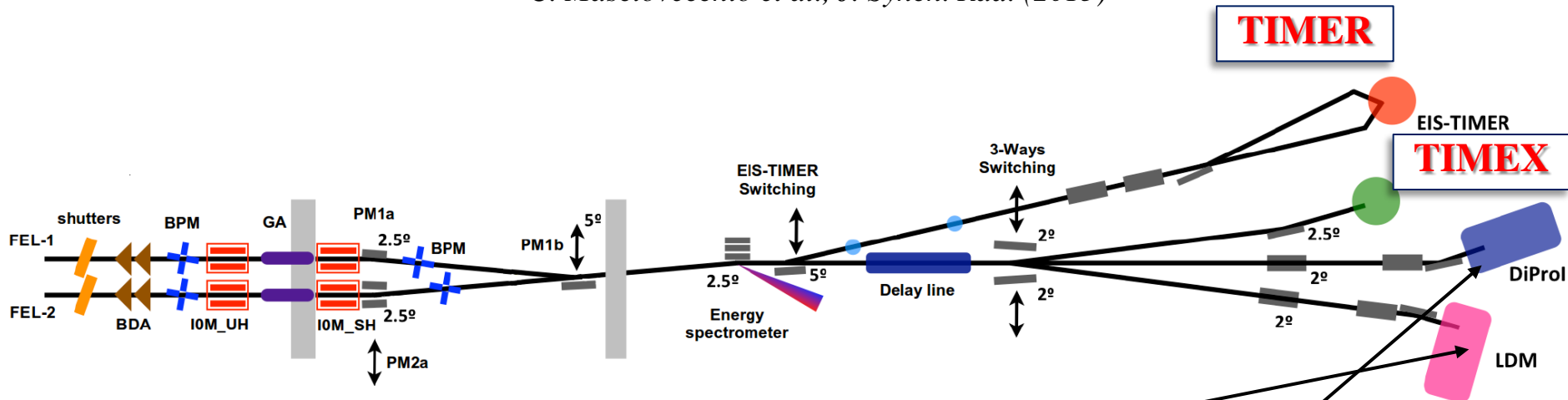

**LDM (Low Density Matter)**

**DIPROI (Diffraction & PROjection Imaging)**

F. Capotondi et al., *J. Synch. Rad.* (2015)

**MagneDYN (Magnetic Dynamics)**

**TeraFERMI (THz beramline)**

# The Experimental Hall

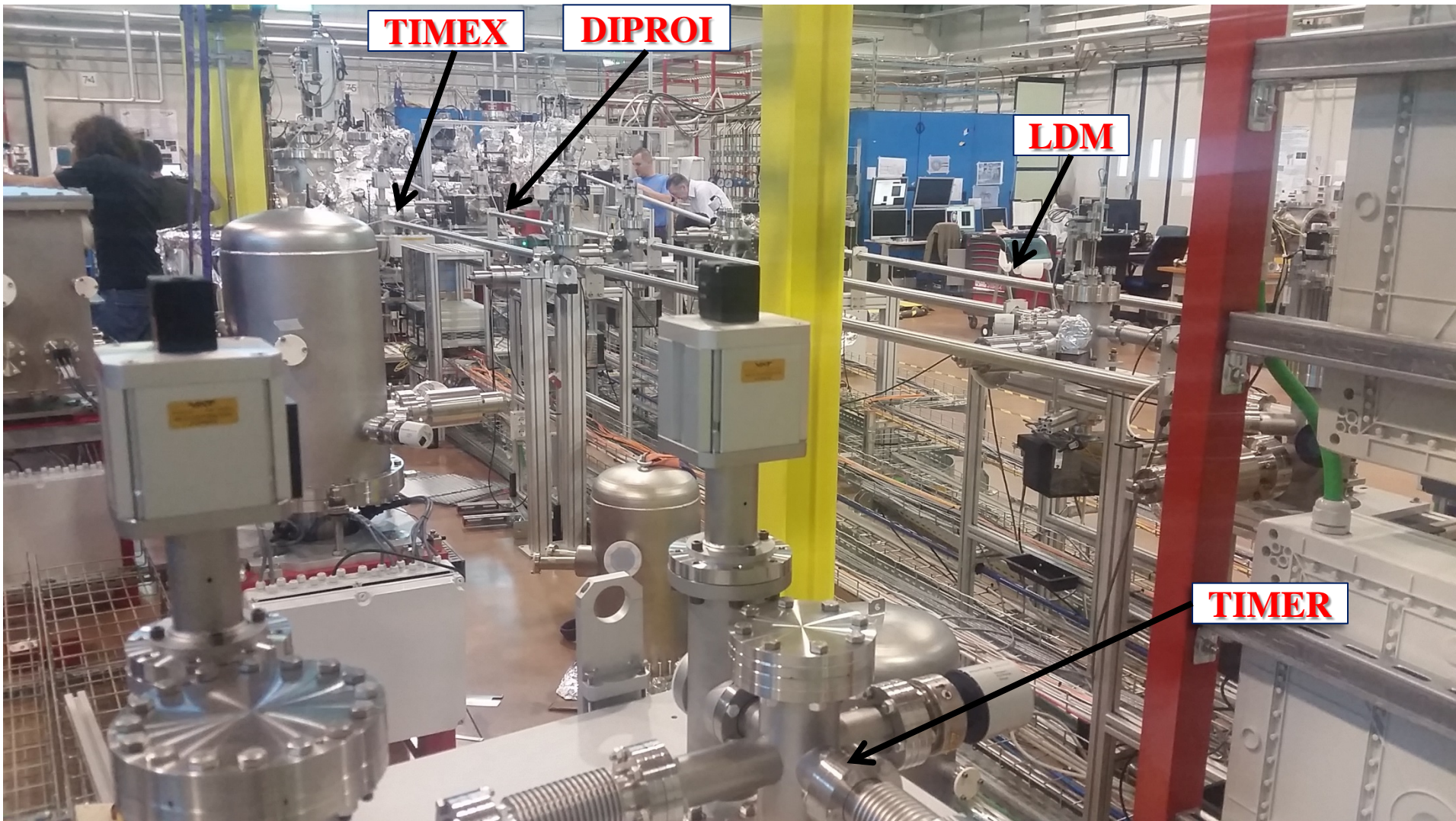



## X-ray **holography** with **customizable reference**

Ideal FTH → overcoming restriction due to the reference wave → single-shot imaging

**Conjugate-gradient algorithm** to recover the image

FTH with an almost **unrestricted choice for the reference**

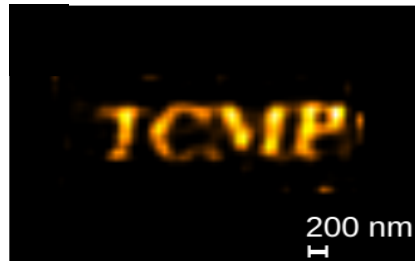
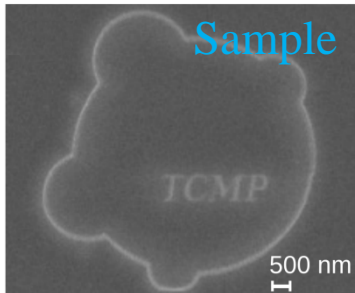
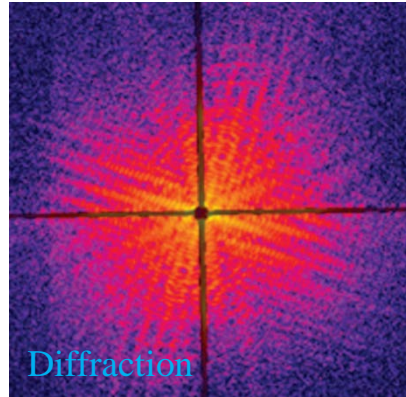
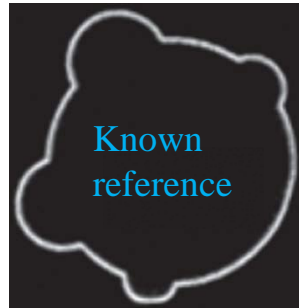

Hologram refined  
with RAAR phase  
retrieval

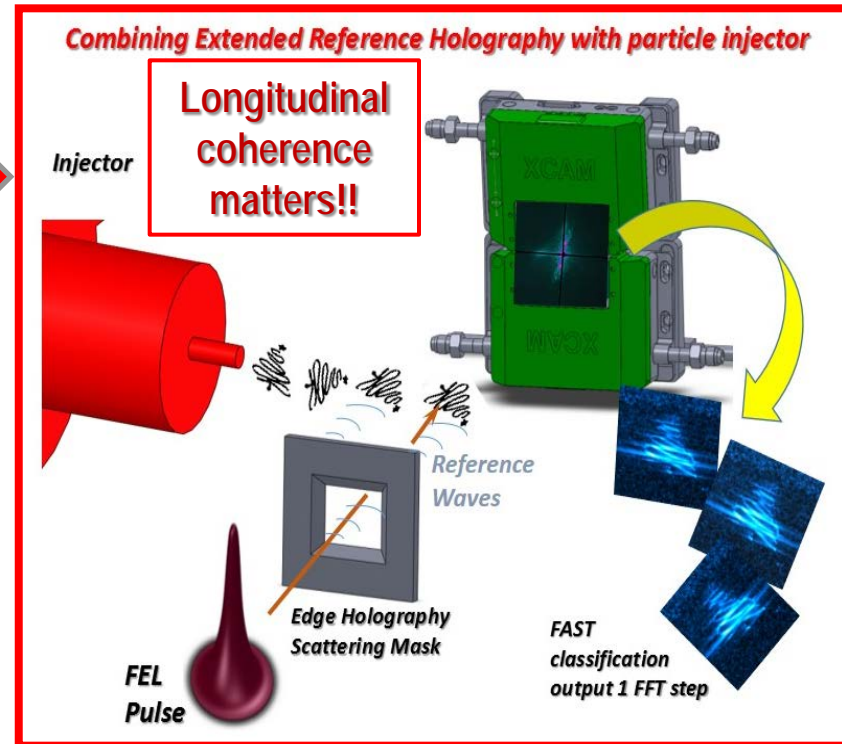

## Coherent control at the attosecond time scale

*K. Prince et al., submitted*

Interference effect among quantum states using single and multiphoton ionization

*C. Chen et al., PRL (1990)*

$$\text{Intensity} = |M1 + M2(\phi)|^2 = |M1|^2 + |M2(\phi)|^2 + 2 \text{Re}(M1 M2(\phi))$$

Use of first (62.974 eV) and second harmonic on  $2p^5 4s$  resonance of Ne

Change of the phases among the two harmonics ‘invented’ by Allaria et al.,

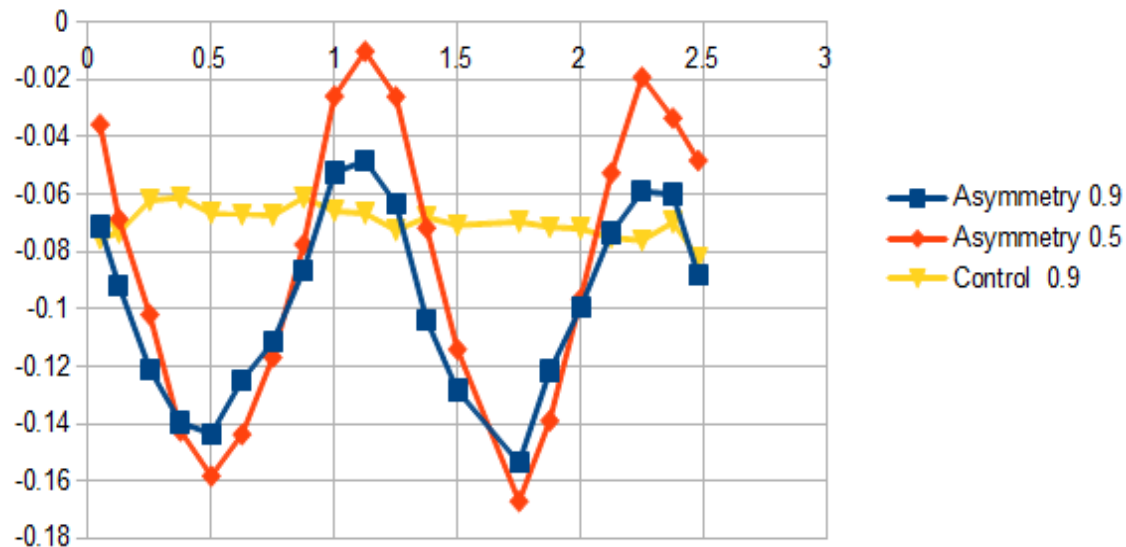

Signal detected as function of phase on the VMI detector

Control of the phase among the two pulses!

The **pump** pulse produces **a change** in the sample

- stimulate a chemical reaction
- non-equilibrium states
- extreme thermodynamic conditions
- ultrafast demagnetization
- coherent excitations
- .....

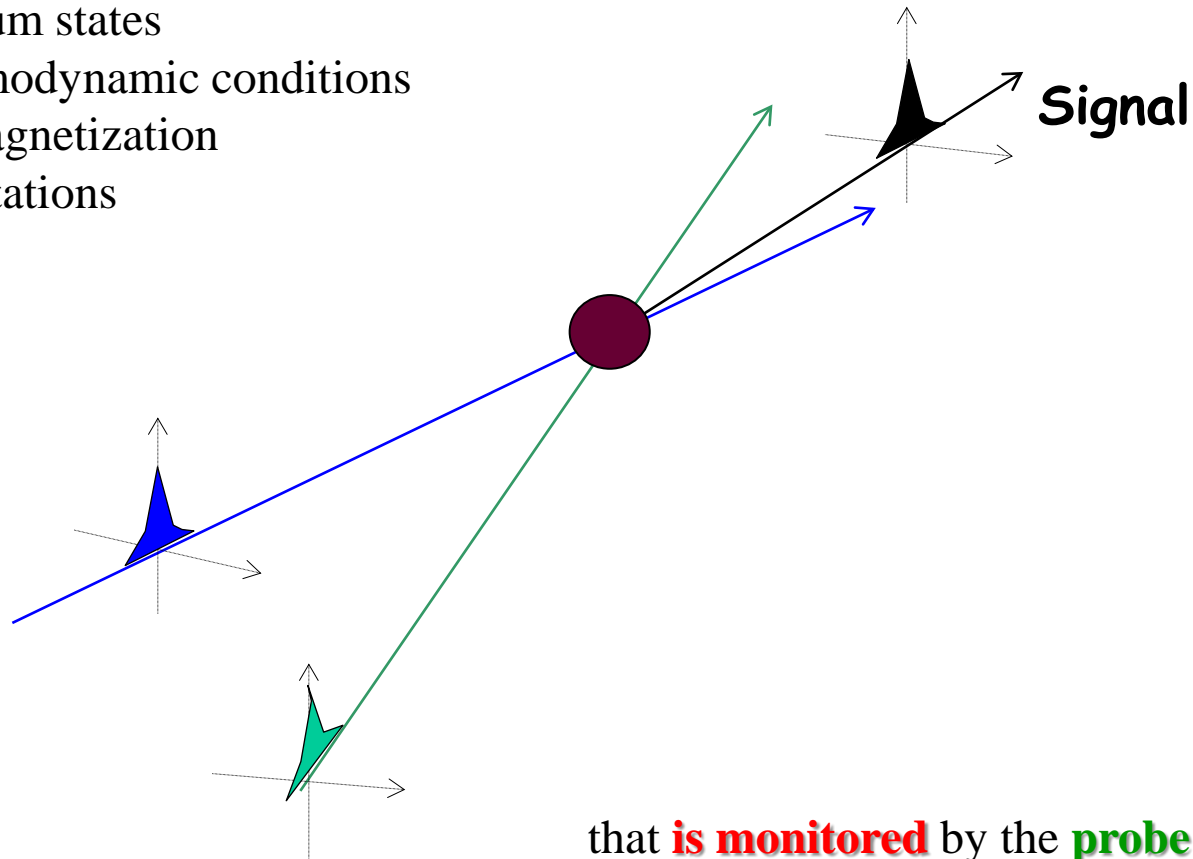

# FEL-pump & Laser-probe

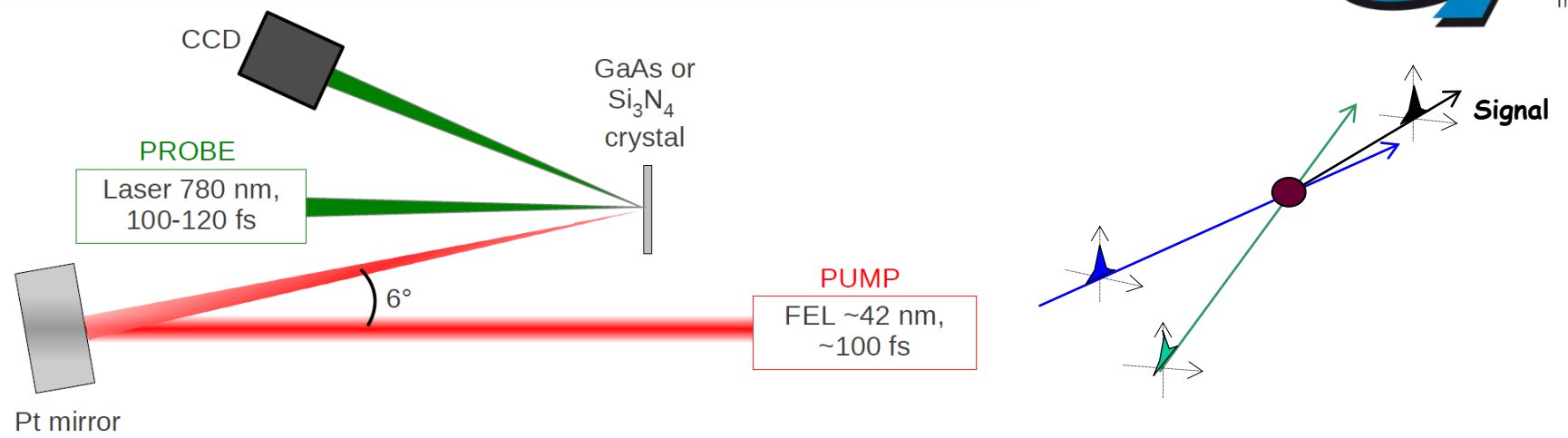

**Jitter < 7 fs**

**WORLD RECORD !!**

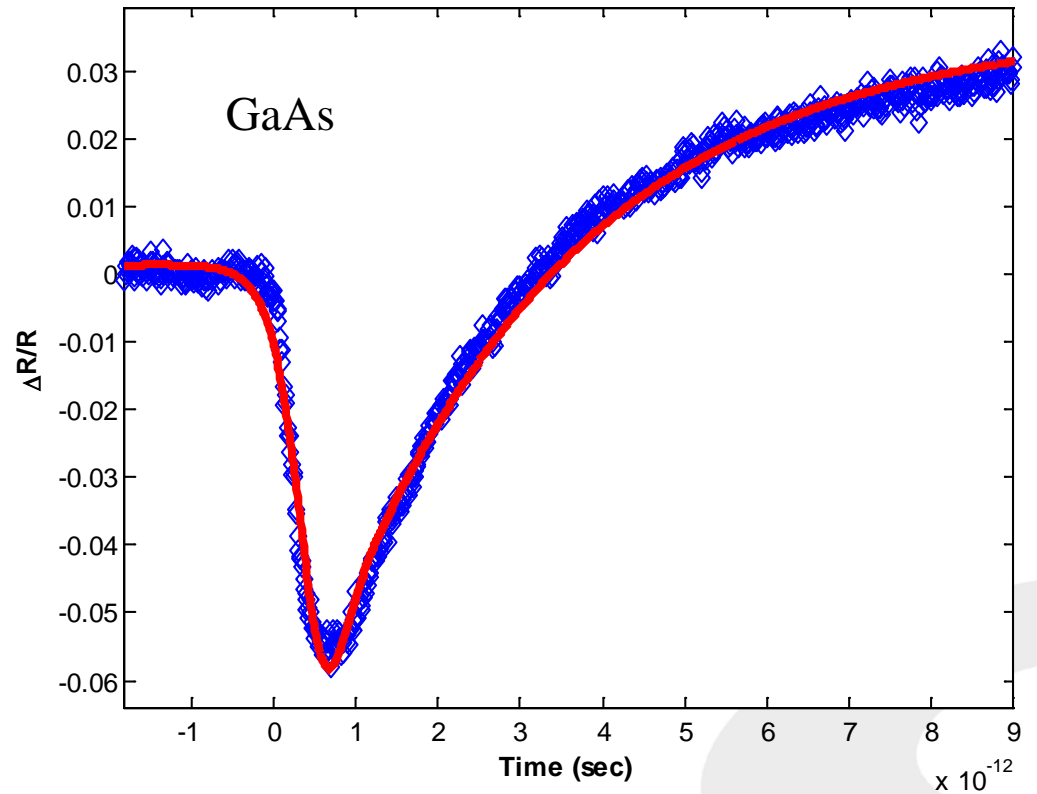

*M. Danailov et al., Opt. Express (2014)*

# Elastic and Inelastic Scattering (EIS)

## The **Sample Side**

**Short** pulses with very high peak power

$\Delta t \sim 100$  fs ; Peak Power  $\sim 5$  GW ;  $E \sim 100$  eV

What happens to the **Sample**?

Non-equilibrium distribution of electrons

Converge (electron-electron & electron-phonon collisions) to equilibrium (Fermi-like)

The intensity of the FEL pulses will determine the process to which the sample will undergo: simple heating, structural changes, ultrafast melting or ultrafast ablation

**TIMER**

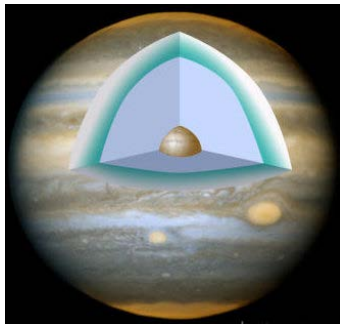

interior of **large planets** and stars

**TIMEX**

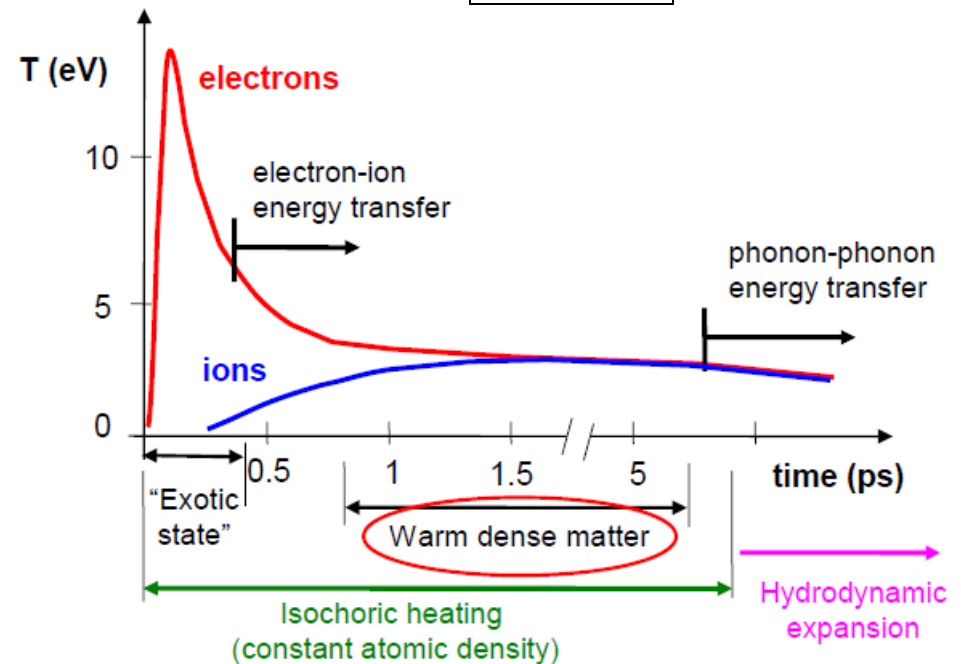

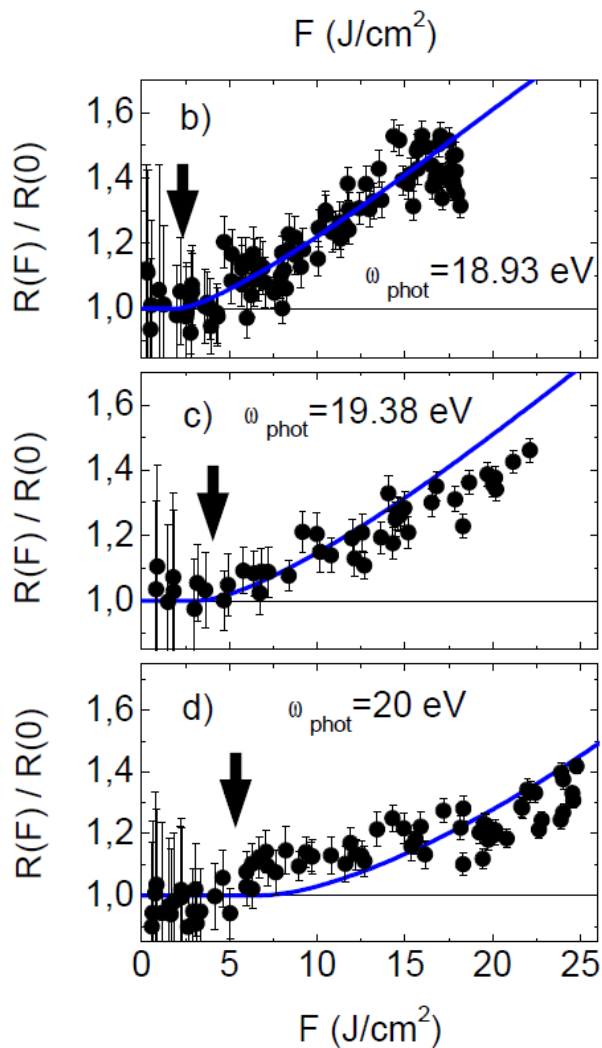

$$R \approx \left| \frac{\sqrt{\epsilon} - 1}{\sqrt{\epsilon} + 1} \right|^2$$

$$Z(F) = \frac{N_e(F)}{N_a} = \frac{m_e \epsilon_0}{e^2 N_a} \int_{-\infty}^{+\infty} \omega_p^2(F, t') G(t') dt'$$

$$\bar{E}(F, t) = \frac{F}{L} \int_{-\infty}^t (1 - R(F, t')) G(t') dt'$$

↓

$$T_e(F)$$

Pump & Probe FEL → Ti

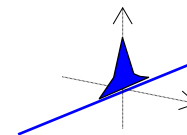

# Pump & Probe on Germanium

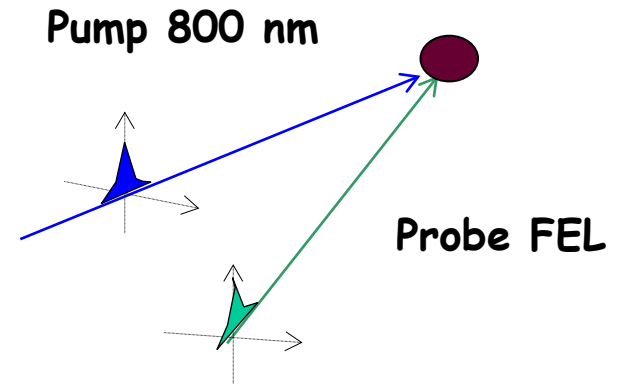
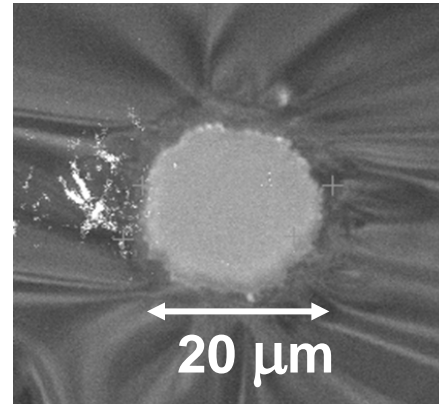
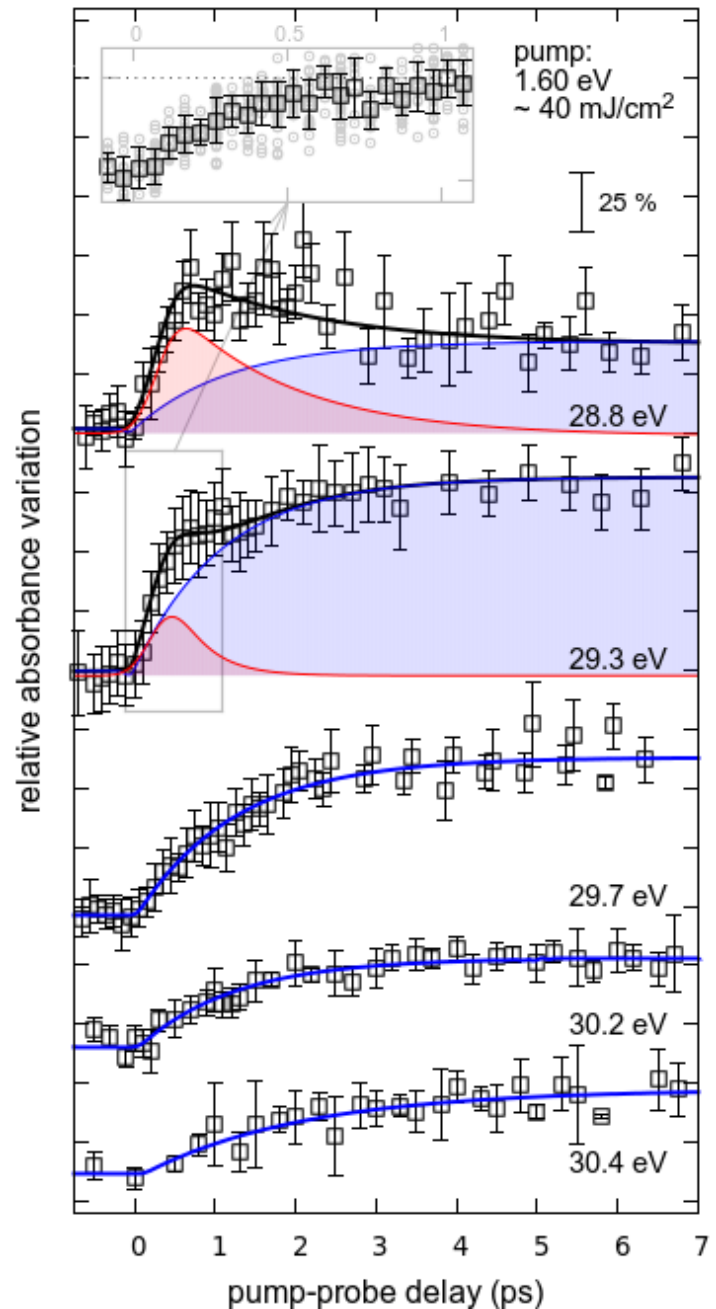

Upon the absorption edge (Fermi level) the spectroscopy is sensitive both to the **Fermi function smearing** (red curve) and to the shift of the edge due to the **metallization** of the sample (blue curve)

## TIMER

**TIME-Resolved spectroscopy of mesoscopic dynamics in condensed matter**

Challenge: Study Collective Excitations in **Disordered Systems**  
in the **Unexplored**  $\omega$ - $Q$  region

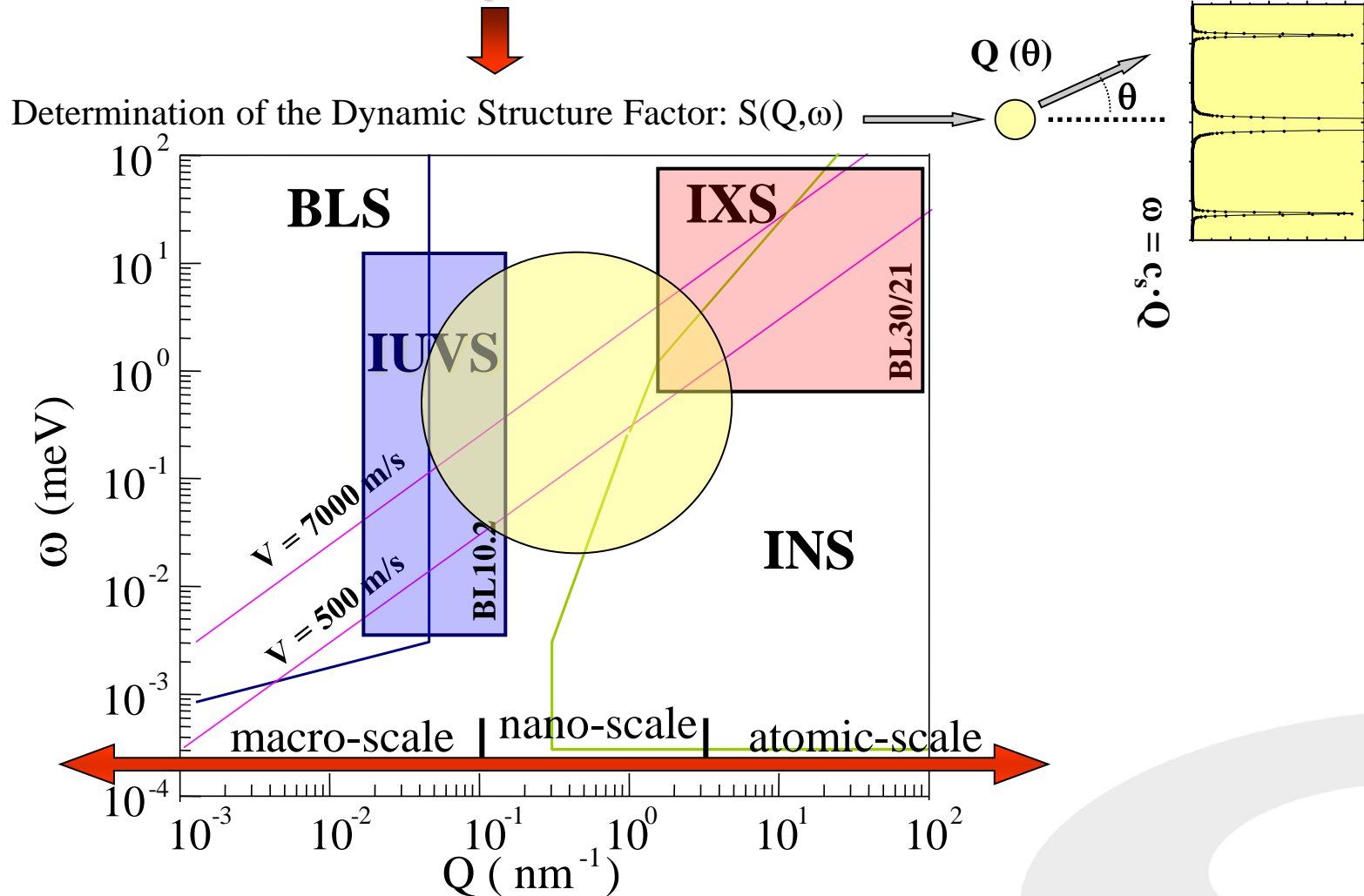



# Why Disordered Systems ?

## UNSOLVED PROBLEMS IN PHYSICS



### Condensed matter physics

#### Amorphous solids

What is the nature of the transition between a fluid or regular solid and a glassy phase? What are the physical processes giving rise to the general properties of glasses?

#### High-temperature superconductors

What is the responsible mechanism that causes certain materials to exhibit superconductivity at temperatures much higher than around 50 Kelvin?

#### Sonoluminescence

What causes the emission of short bursts of light from imploding bubbles in a liquid when excited by sound?

#### Turbulence

Is it possible to make a theoretical model to describe the statistics of a turbulent flow (in particular, its internal structures)? Also, under what conditions do smooth solution to the Navier-Stokes equations exist?

Glass is a **very general state** of condensed matter → a large variety of systems can be transformed from liquid to glass

The liquid-glass transition cannot be described in the framework of classical phase transitions since  $T_g$  depends on the **quenching rate** → one cannot define an **order parameter** showing a critical behaviour at  $T_g$

# Why at the nanoscale ?

The nature of

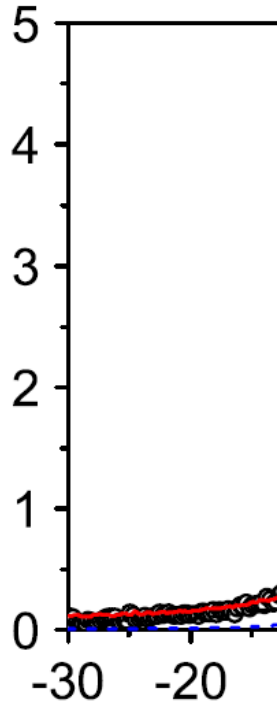

Funda:

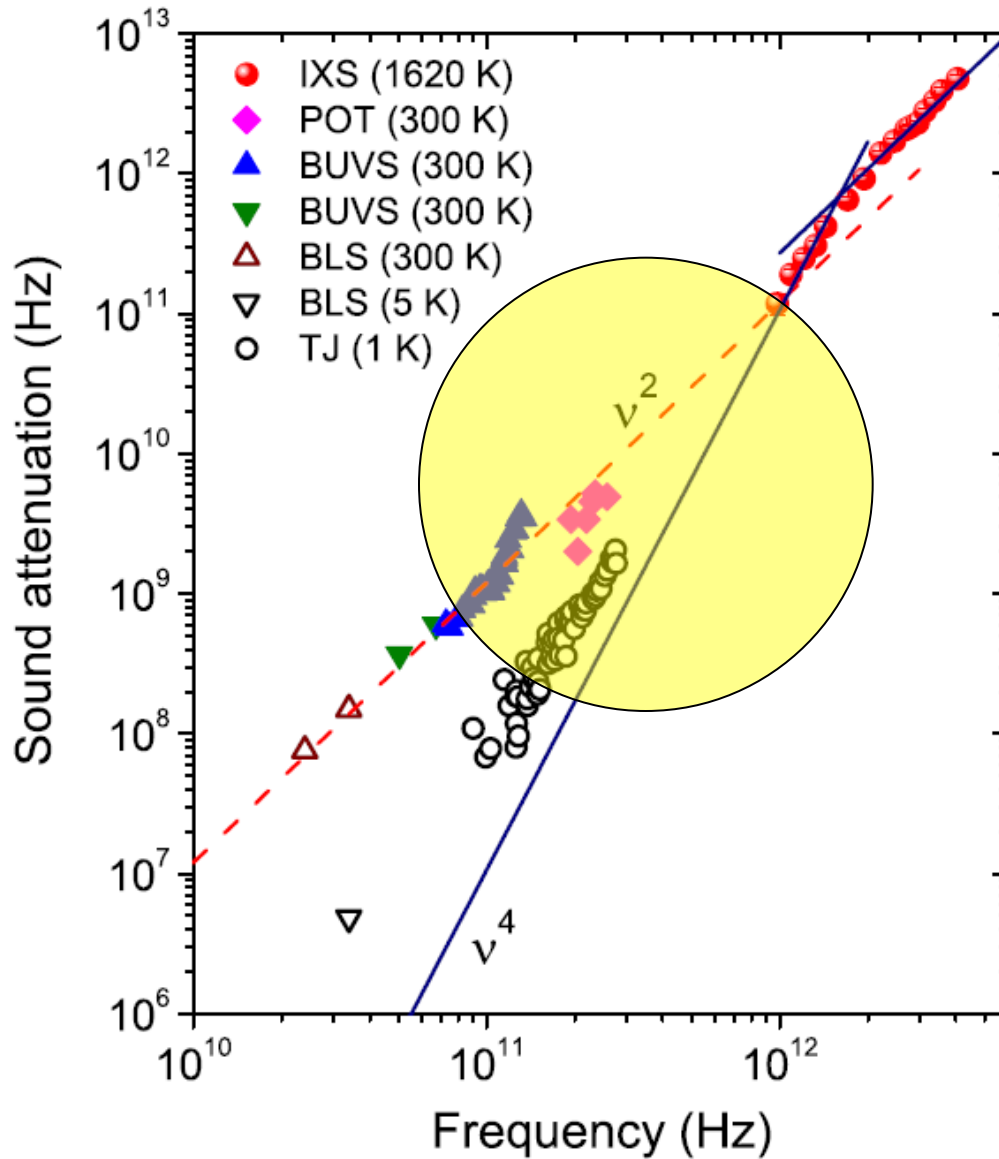

near (V-SiO<sub>2</sub>)

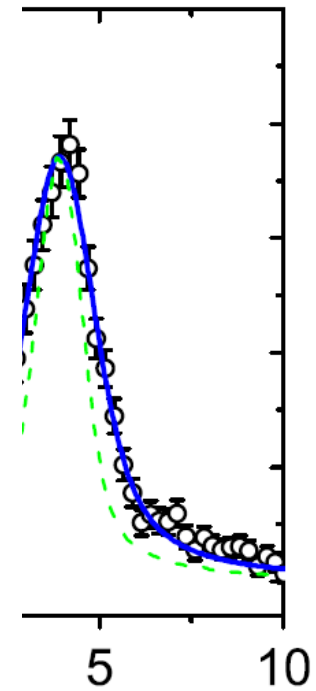

# Why at the nanoscale ?

Water exhibits very **unusual** properties:

- Negative volume of melting
- Density maximum in the normal liquid range
- Isothermal compressibility minimum in the liquid
- Increasing liquid fluidity with increasing pressure

“...water’s puzzling properties are not understood and **63** anomalies that distinguish water from other liquids remain unsolved...” H. E. Stanley, *Physica A* (2007)

$T_g$   $T_H$   $T_M$

---



**nature** International weekly journal of science

## Ultrafast X-ray probing of water structure below the homogeneous ice nucleation temperature

*J. A. Sellberg et al., Nature (2014)*

The hope now is that these observations and our detailed structural data will help identify those theories that best describe and explain the behaviour of water.

# Why at the nanoscale ?

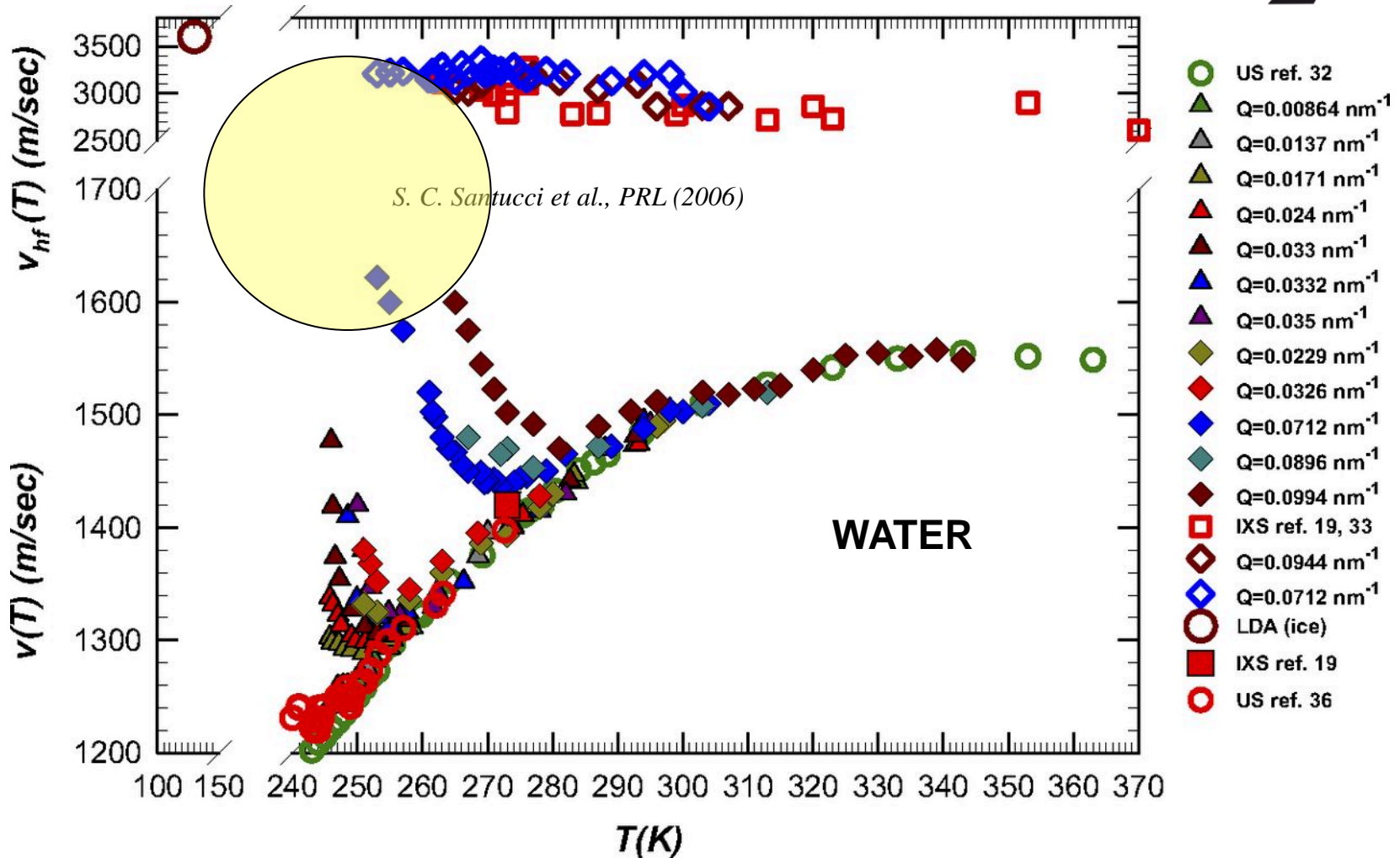

.....only by treating water as a viscoelastic system is it possible to understand the microscopic origin of water anomalies. The proposed scenario here has been developed using a dynamic approach.....

*F. Mallamace et al., PNAS (2013)*

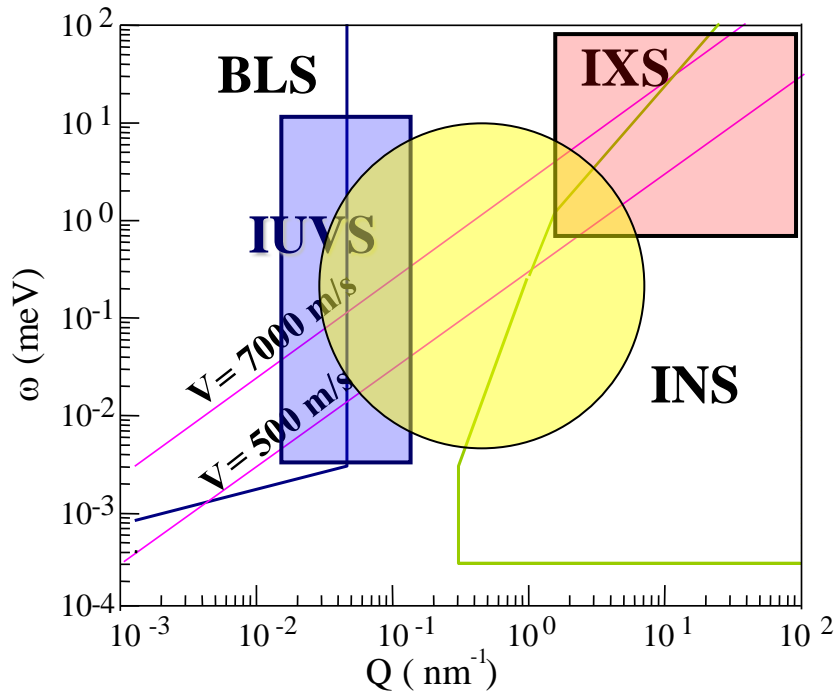

**Solution:** Free Electron Laser based Transient Grating Spectroscopy

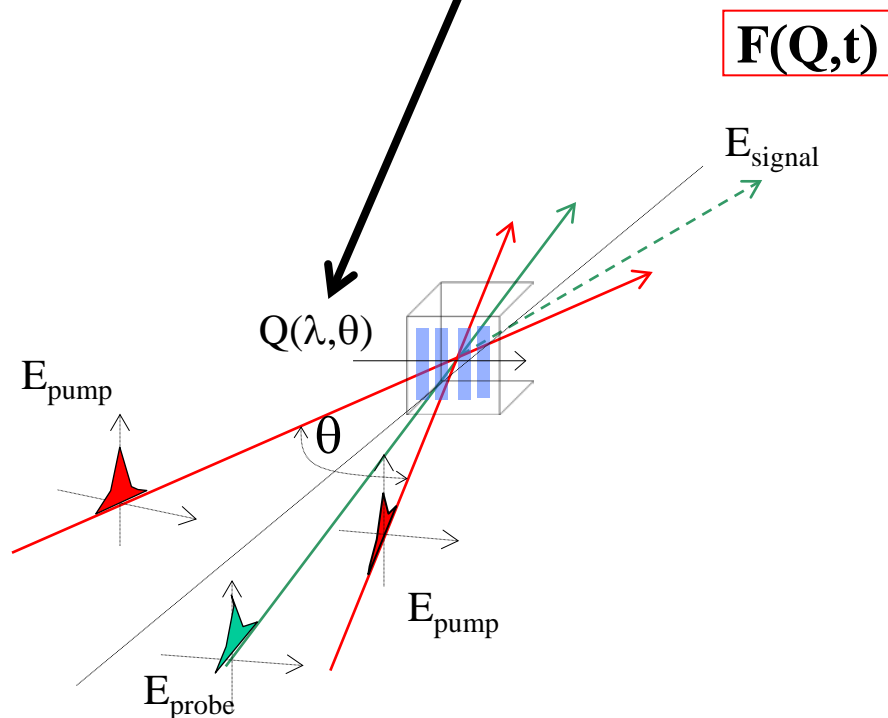

European Research Council

Funded Grant: 1.8 M€

# The Spectrum

Optical absorption  $\rightarrow$  Temperature Grating  $\rightarrow$  Time-dependent Density Response

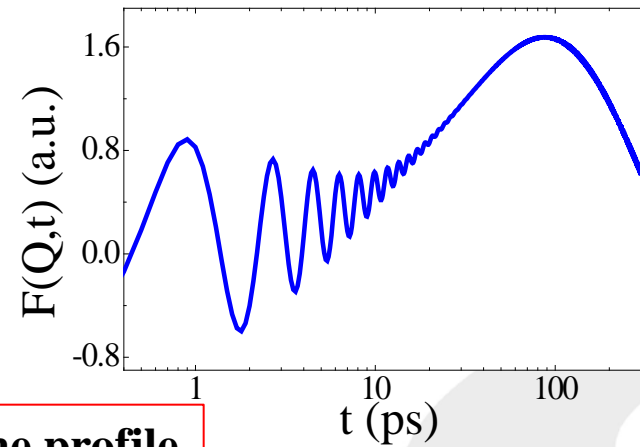
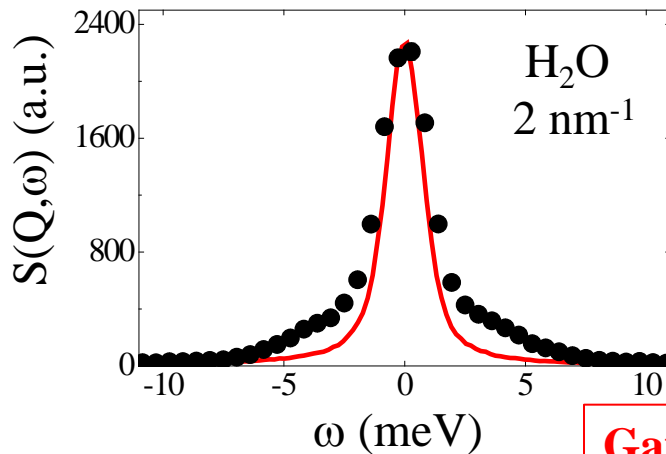
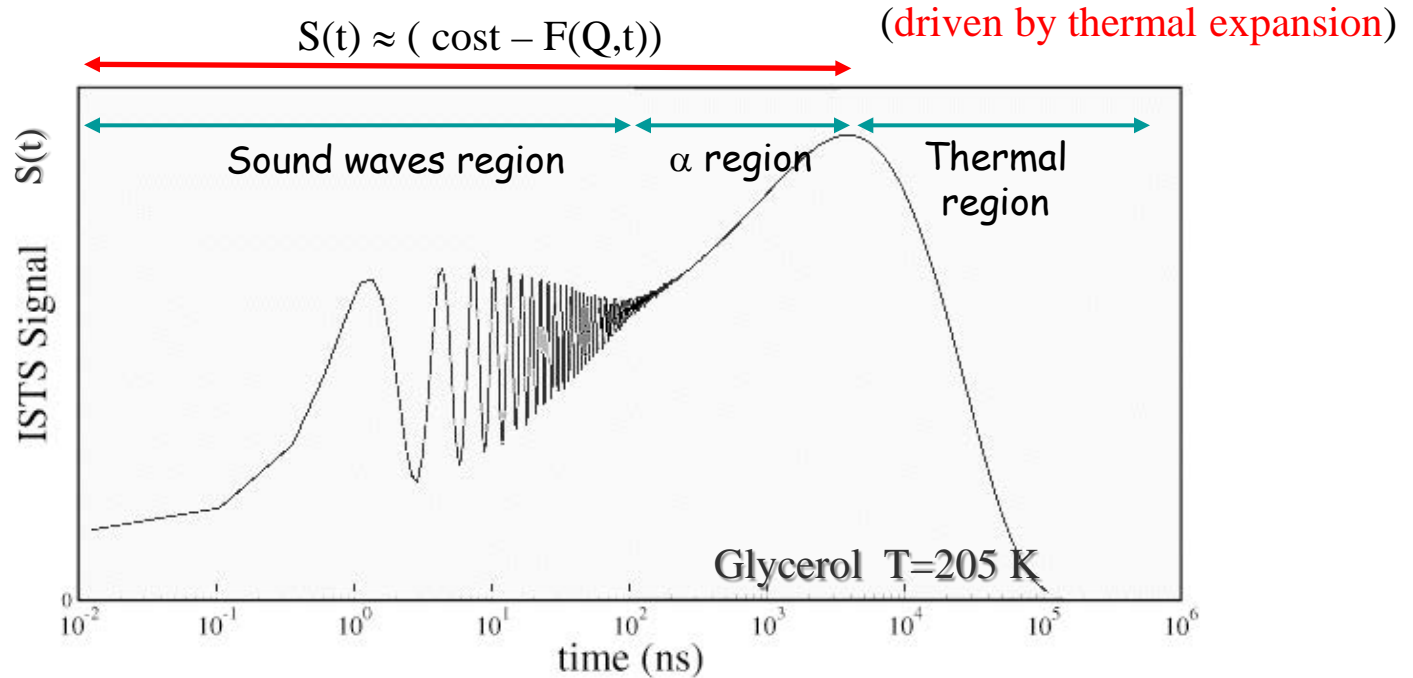

**Gaussian-like time profile**

# Typical Infrared/Visible Set-Up

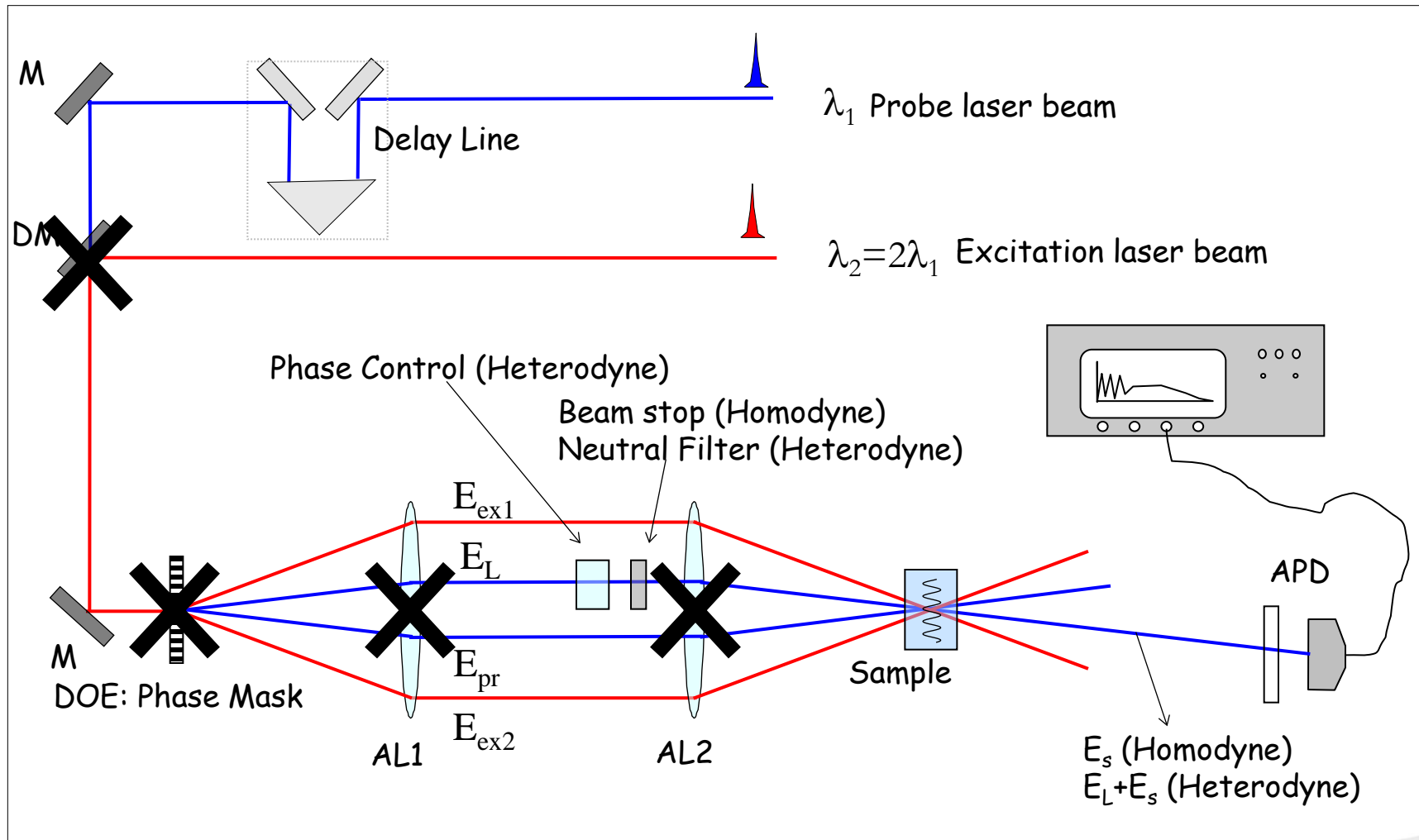

**Challenge:** Extend and modify the set-up for UV Transient Grating Experiments

# TIMER Layout

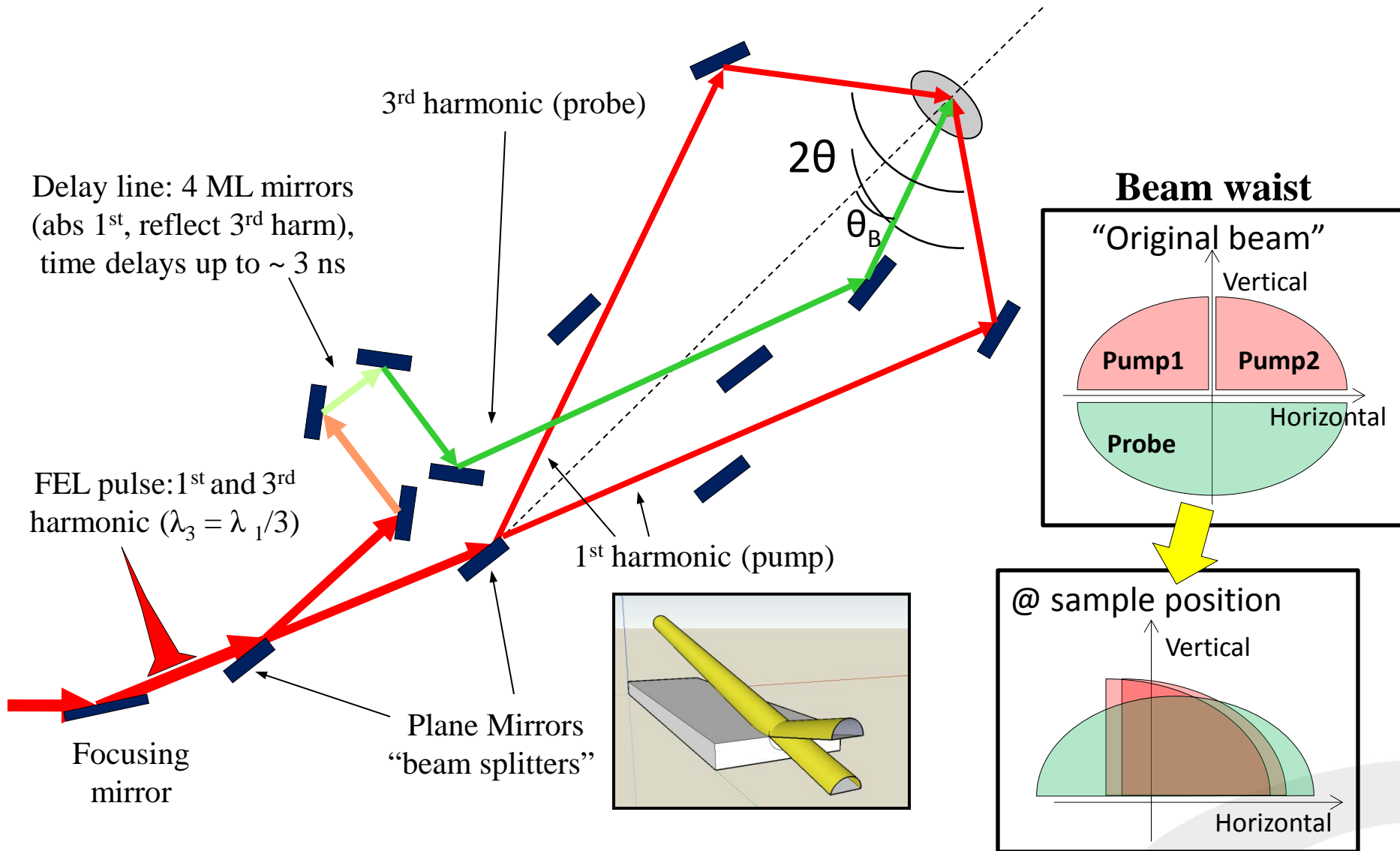



Liquid sample (dimethylsulfossil)

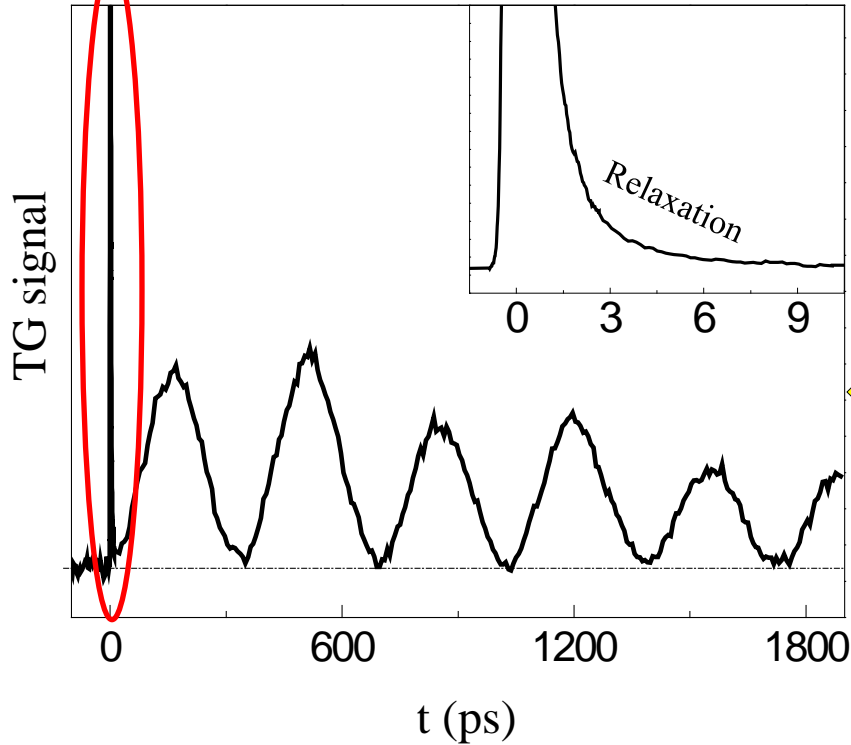

Pump energy ~ 25  $\mu\text{J}/\text{pulse}$

Probe energy ~ 5  $\mu\text{J}/\text{pulse}$

Beam dimensions ~ 50÷200  $\mu\text{m}$

$\theta = 26^\circ$ ,  $\Delta t = 150 \text{ fs}$ ,  $\lambda = 800 \text{ nm}$

← Signal ~ 0.1÷1 pJ  $\rightarrow I_{\text{signal}}/I_{\text{probe}} \sim 10^{-7}$

Surface (200 nm Au on Si)

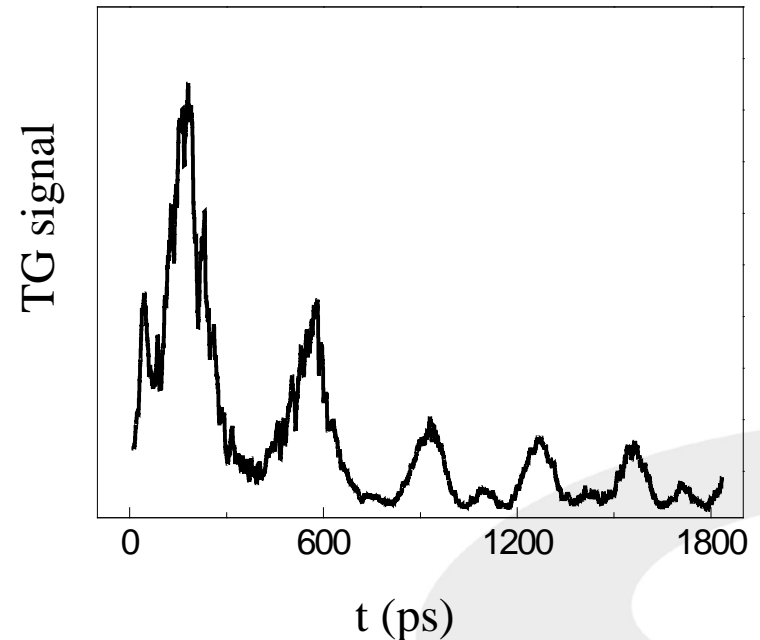

$$\text{Signal} \sim [A \cdot \sin(\omega t) e^{-\Gamma_1 t} + B(1 - \cos(\omega t)) e^{-\Gamma_2 t}]^2$$

Sound velocity = 1486 +/- 2 m/s (OK)

*F. Bencivenga et al., NIMA (2010), R. Cucini et al., NIMA (2011),  
R. Cucini et al., Opt. Lett. (2011), R. Cucini et al., Opt. Lett. (2014)*

# Expected TG signal

## SiO<sub>2</sub> sample

Relative density variation  
@ z=0, considering only optical absorption

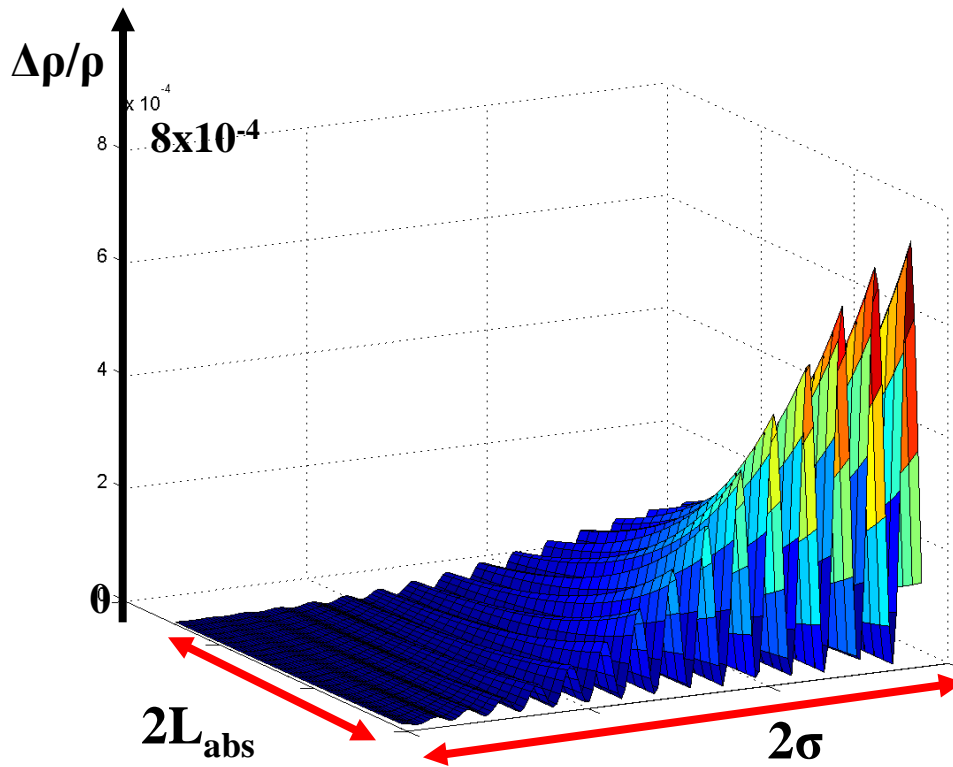

## Interference @ sample position

(@ z=0, λ=60 nm, θ=9.2°)

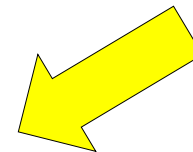
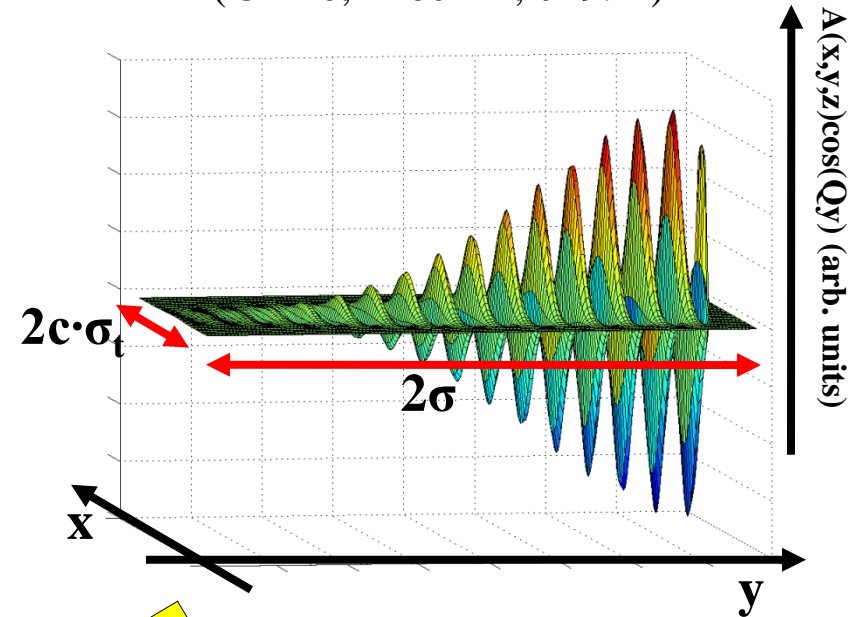

$$\Delta\rho/\rho(x,y,z) \sim \alpha \Delta E(x,y,x) / (\Delta V c_v \rho)$$

$\downarrow$   $25.5 \cdot 10^{-6} \text{ K}^{-1}$        $\uparrow$   $840 \text{ J kg}^{-1} \text{ K}^{-1}$        $\downarrow$   $2200 \text{ kg m}^{-3}$

Adiabatic heating of the sample in the illuminated region < 3 °C

# Transient Grating Experiments on V-SiO<sub>2</sub>

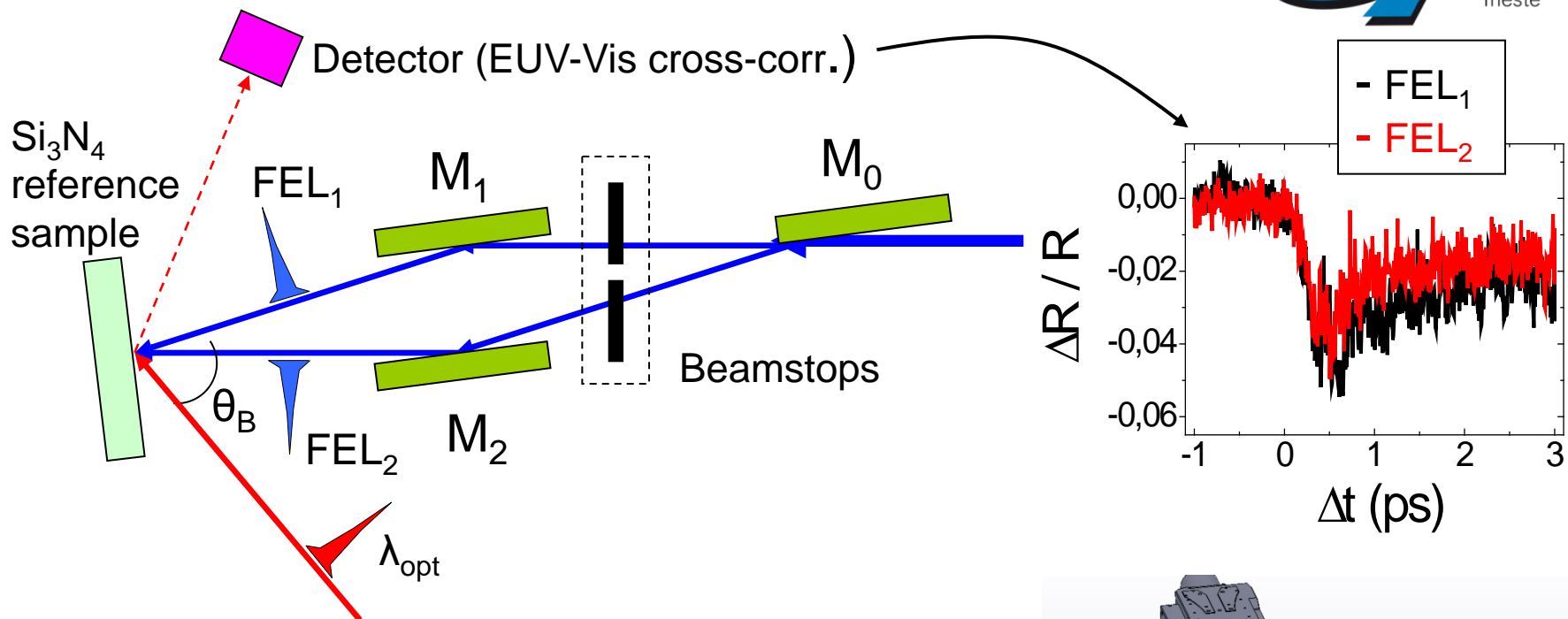

$\Delta t_{\text{FEL-FEL}} = \pm 0.5 \text{ ps at } 2\theta = \text{constant}$

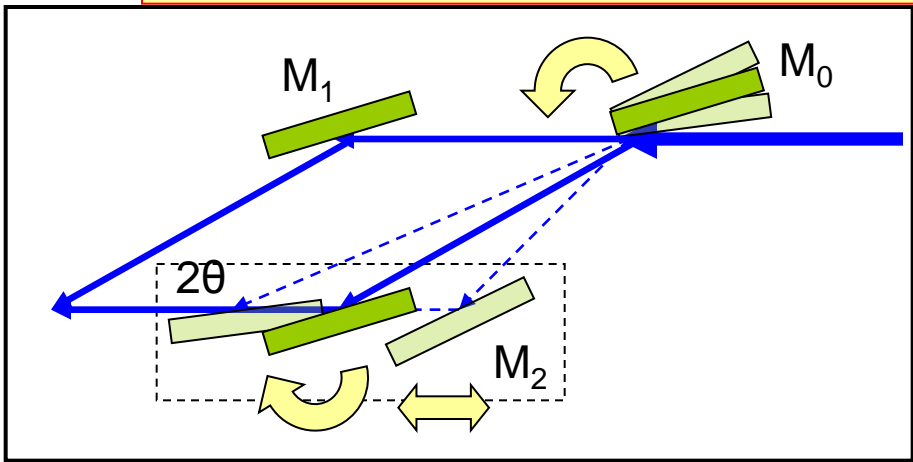

$\theta = 3^\circ; \lambda_{\text{FEL}} \approx 30 \text{ nm}$   
 $\theta_B \approx 45^\circ; \lambda_{\text{laser}} = 390 \text{ nm}$

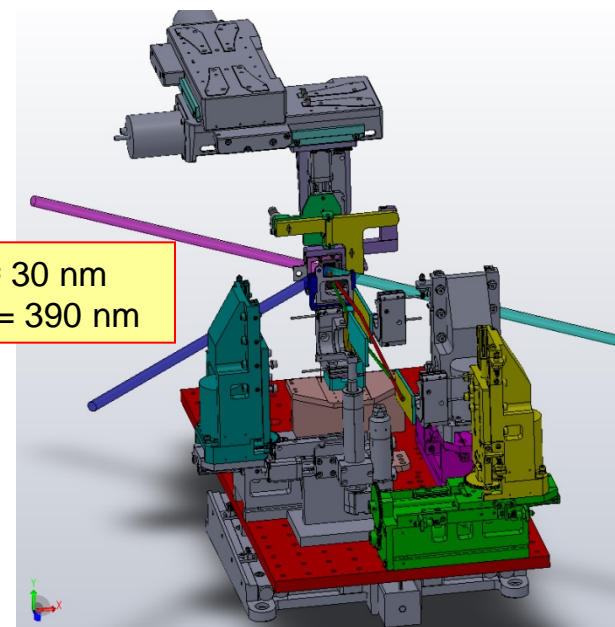

# Transient Grating Experiments on V-SiO<sub>2</sub>

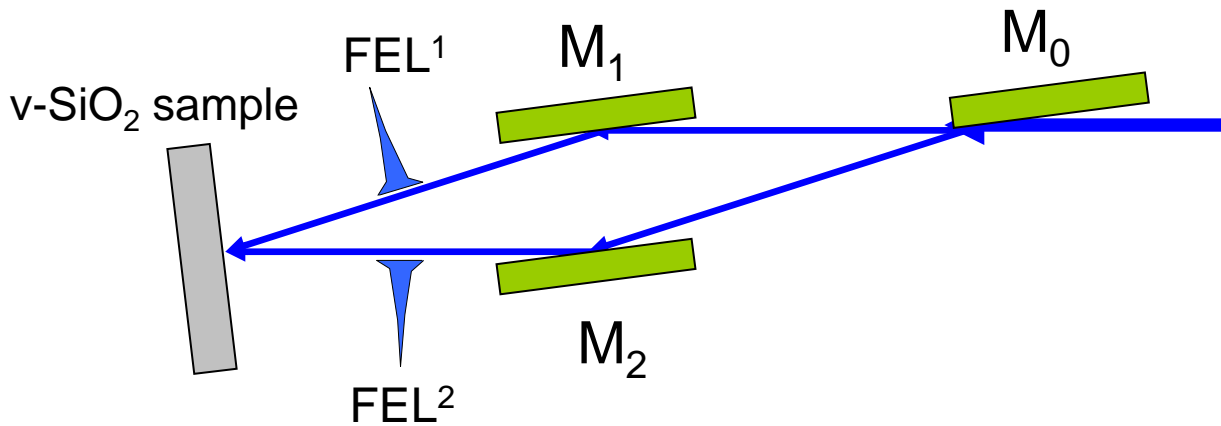

Inprints on SiO<sub>2</sub>

$$\rightarrow 2\theta = 5.975^\circ$$

Grating visibility after  
multi-shot exposure

$\rightarrow$  FEL<sup>1</sup>-FEL<sup>2</sup> optical path  
difference  $< \lambda_{\text{FEL}}$

Permanent gratings on  
SiO<sub>2</sub> (after 1000's shots  
@ FEL flux  $> 50$  mJ/cm<sup>2</sup>)

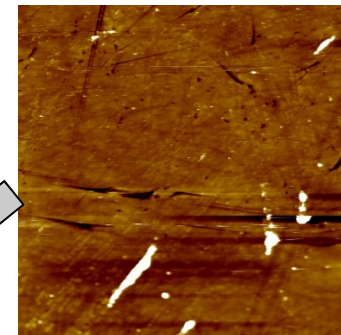
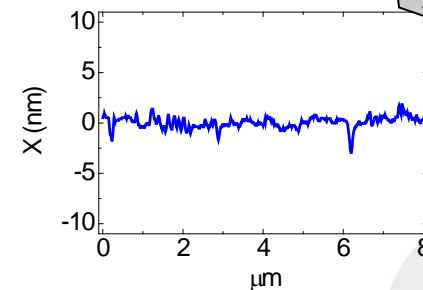
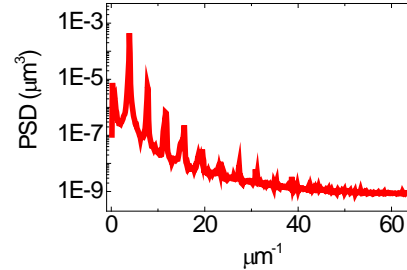
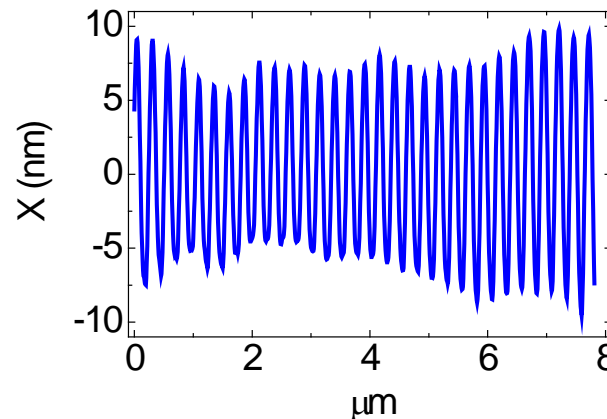
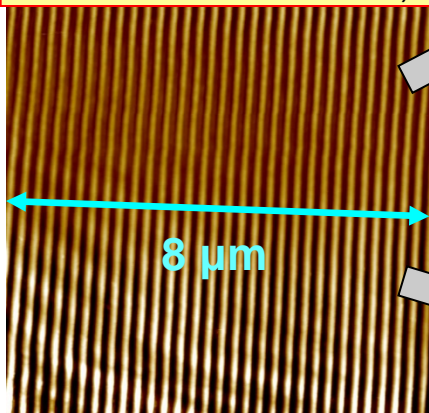

Clean sample

## Four-wave mixing experiments with extreme ultraviolet transient gratings

*F. Bencivenga et al., Nature 2015*

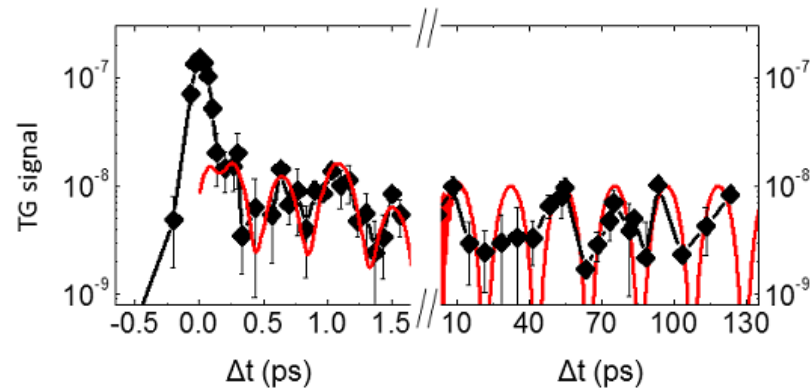
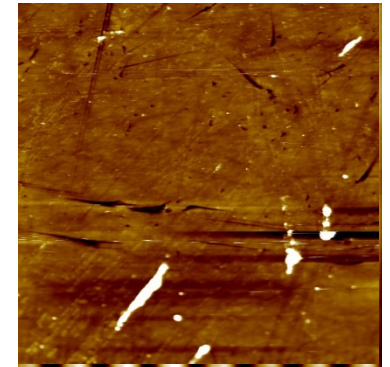
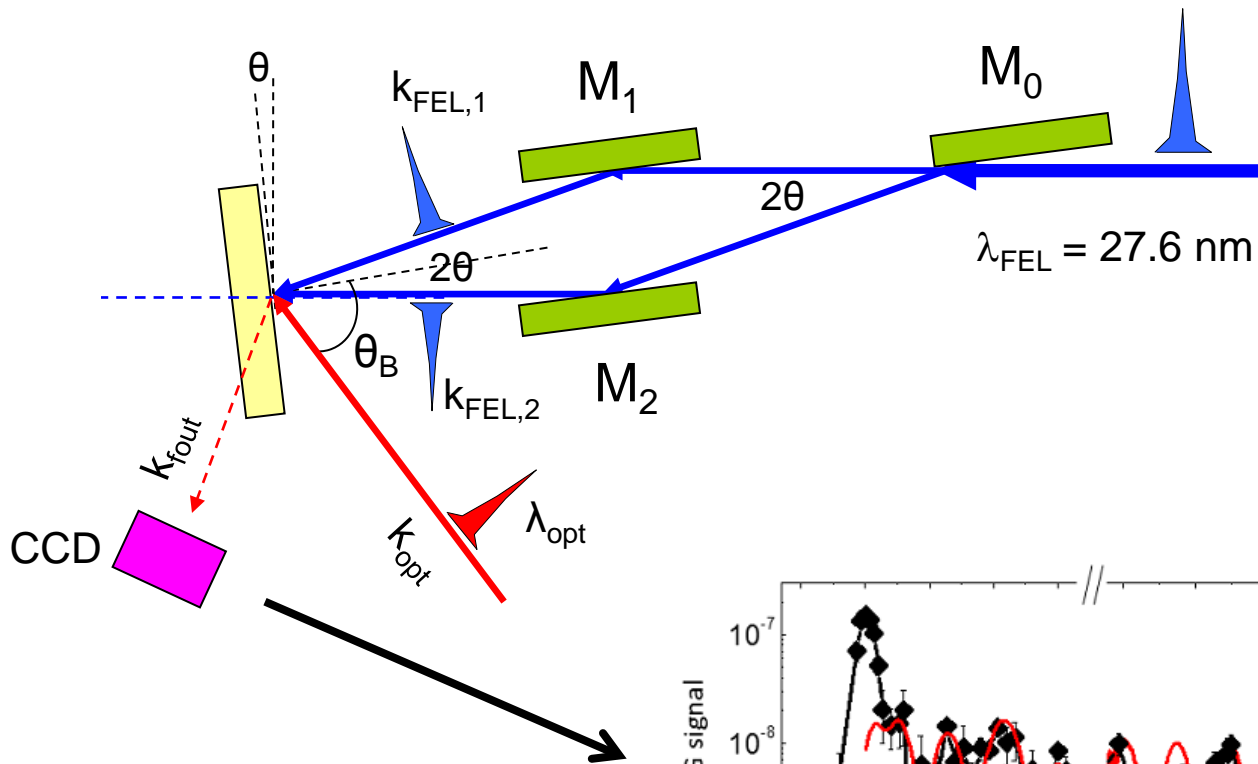

# Transient Grating Experiments on V-SiO<sub>2</sub>

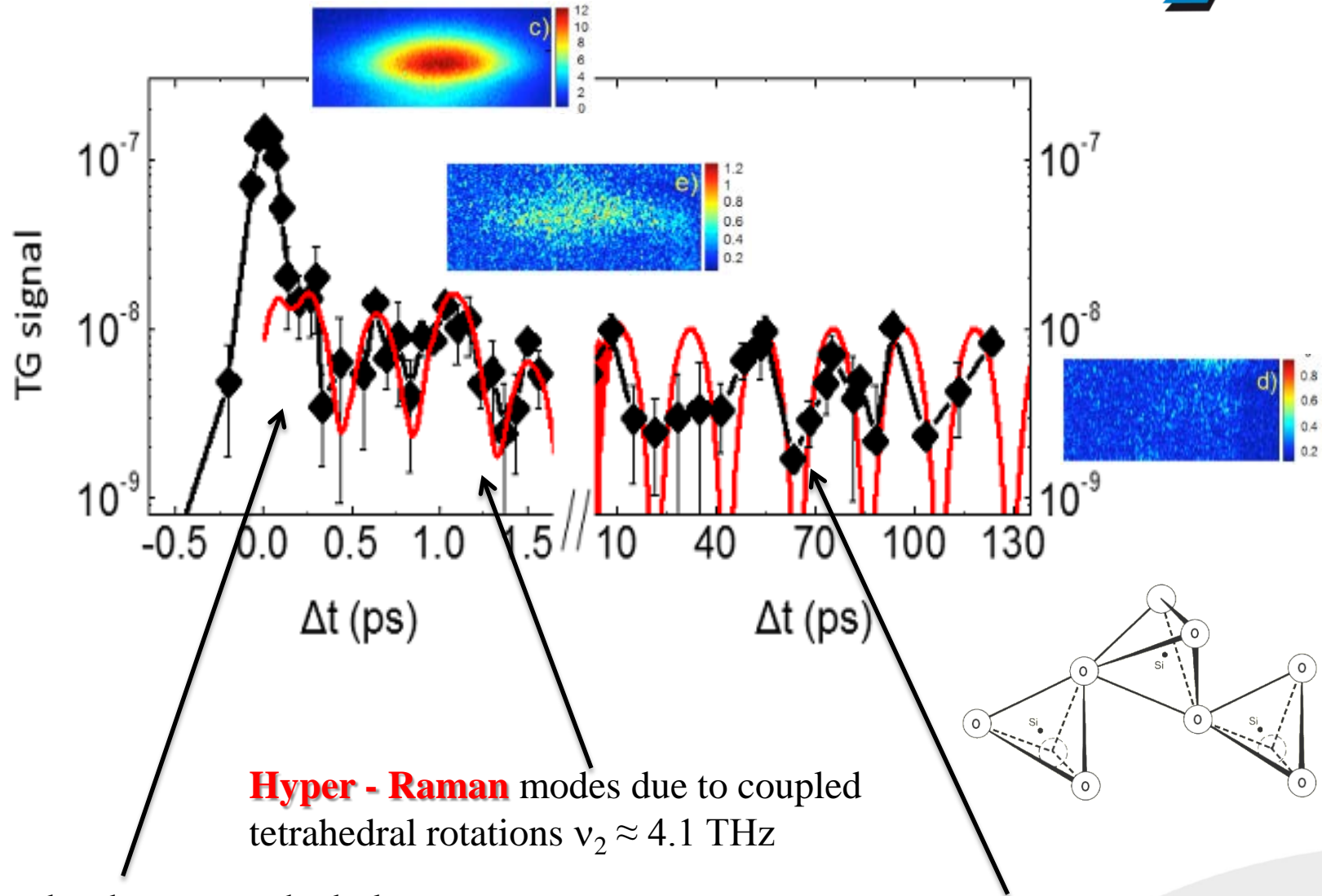

**Raman** modes due to tetrahedral bending  $\nu_1 \approx 1.2$  THz

**Hyper - Raman** modes due to coupled tetrahedral rotations  $\nu_2 \approx 4.1$  THz

**Acoustic**-like excitations

**Heterodyning** is a signal processing technique invented in 1901 by R. Fessenden

$$I = |E_{\text{ref}}|^2 + |E_s(t)|^2 + 2|E_{\text{ref}} E_s(t)| \cos(\phi_{\text{ref}} - \phi_s)$$

Time independent local field

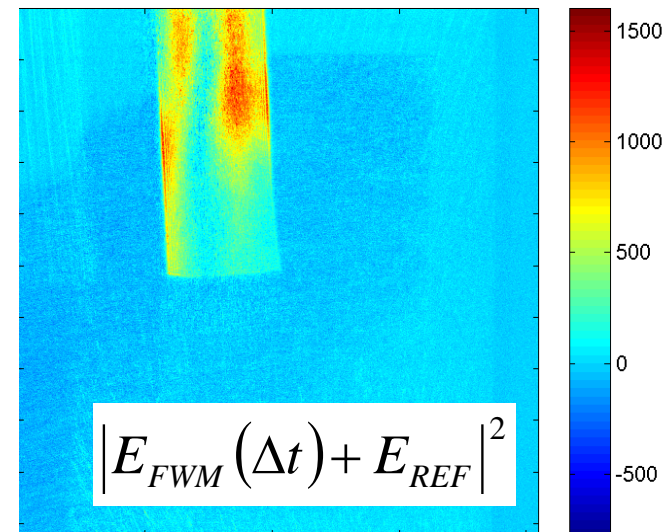
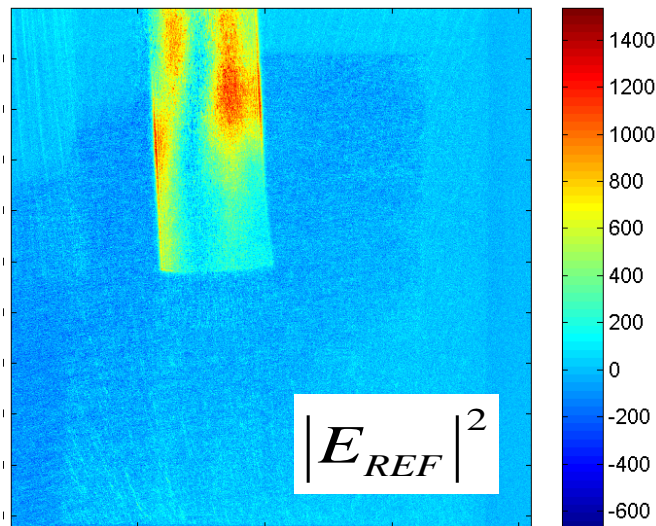
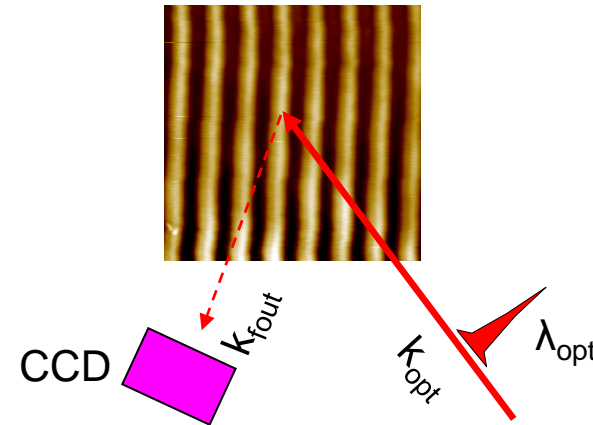

# Heterodyning with FEL

Heterodyne

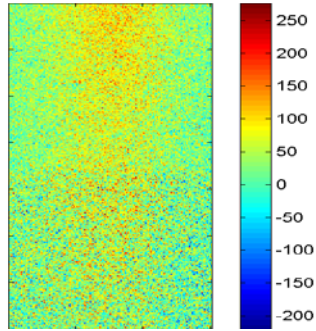

Homodyne

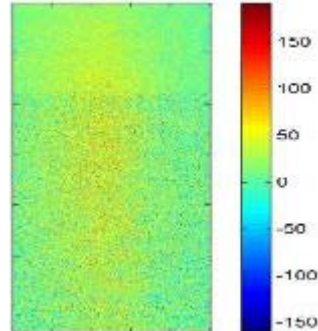

VS

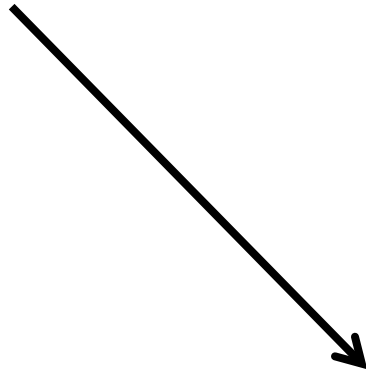

Clear intensity **increase !!!**

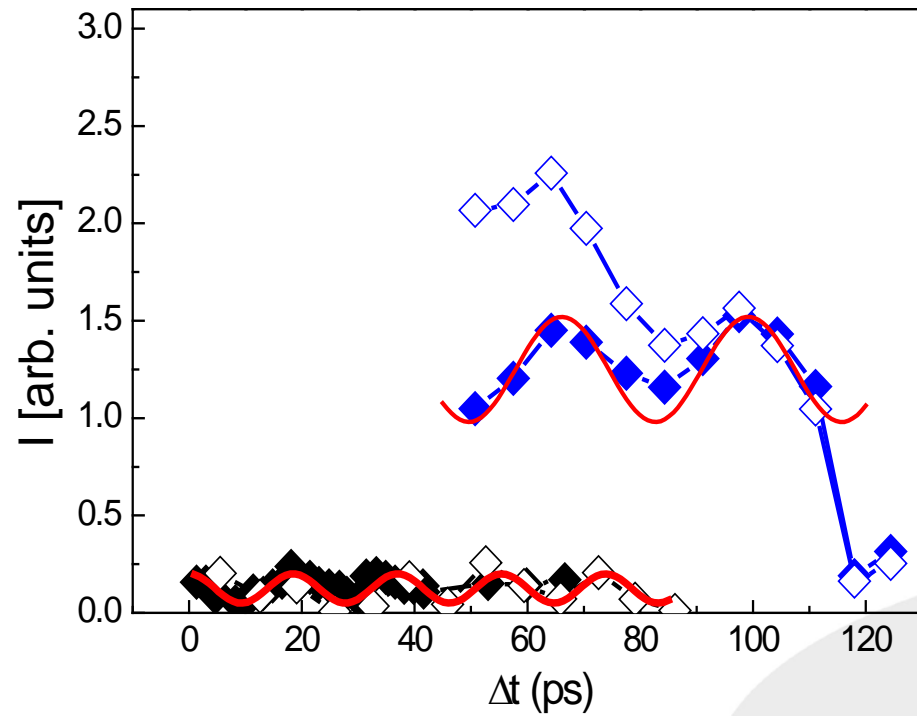





N. Bloembergen 1981



$$P_i = \chi_{ij}^{(1)} E_j + \chi_{ijk}^{(2)} E_j E_k + \chi_{ijkl}^{(3)} E_j E_k E_l + \dots$$

is the lowest nonlinear order for centrosymmetric materials →  
→ **all materials** have a third-order nonlinear response.

## FOUR-WAVE MIXING SPECTROSCOPY

The nonlinearity  $\chi^{(3)}$  describes a coupling between four light waves, and some

N. Bloembergen Nobel Lecture 1981

# Phase Matching

**Clean** technique

$$I_{\text{FWM}} \sim \chi^{(3)} I_1 I_2 I_3 \cdot \text{sinc}(\Delta \mathbf{k}_{\text{FWM}} \cdot L/2)$$

$$\Delta \mathbf{k}_{\text{FWM}} = \mathbf{k} - \mathbf{k}_{\text{out}}$$

**Phase matching** → non linear emission from  $N$  elementary emitters placed at different sample locations within  $2\delta k^{-1}$  (coherence length of the non-linear process) **adds in phase** (intensity grows up as  $N^2$ ) **along  $\mathbf{k}_{\text{out}}$**

→  $\delta k > 0$  because, e.g., bandwidth and divergence



**Directionality** + **coherent addition** may lead to a dominating non linear signal

**FERMI**: pulses with Fourier-limited bandwidth → increase in  $\delta k^{-1}$  → substantial ( $\sim N^2$ ) increase of  $I_{\text{FWM}}$  along  $\mathbf{k}_{\text{out}}$

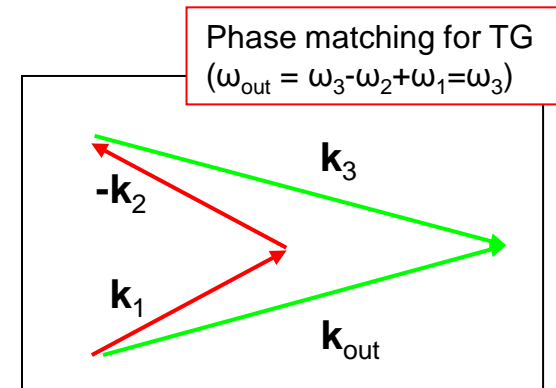
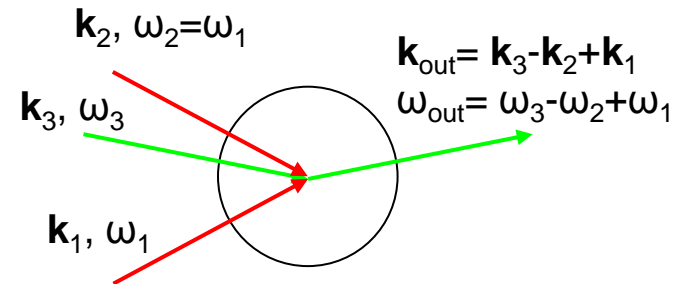

# Four Wave Mixing at FEL's

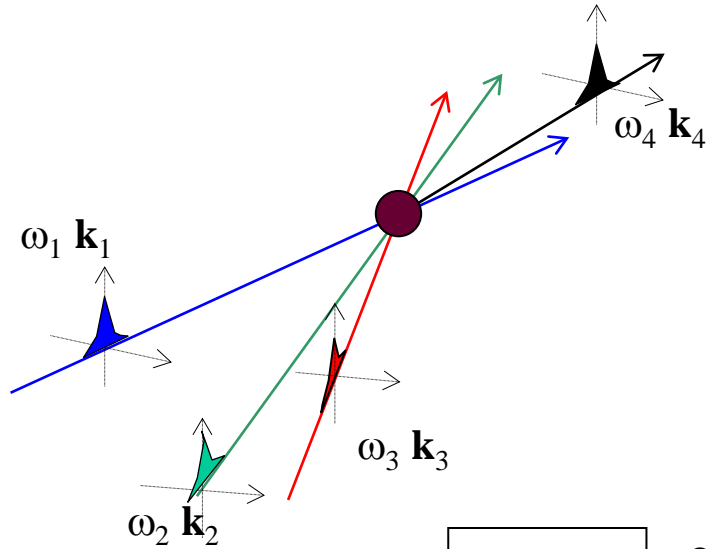

**Four Wave Mixing** techniques are:  
Stimulated Raman Gain Spectroscopy,  
Photon Echo and Raman Induced Kerr  
Effect Spectroscopy, Femtosecond  
Stimulated Raman Scattering and Coherent  
Antistokes Raman Scattering (**CARS**)

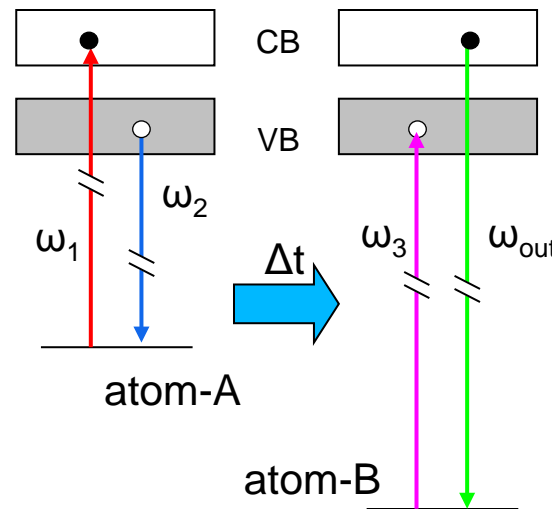

Measure the coherence between the two different sites  $\rightarrow$  tuning energies and time delay makes possible to chose where a given excitation is created, as well as where and when it is probed

$\downarrow$   
delocalization of electronic states and charge/energy transfer processes.

*S. Tanaka and S Mukamel, PRL (2002)*

# Four Wave Mixing at FEL's

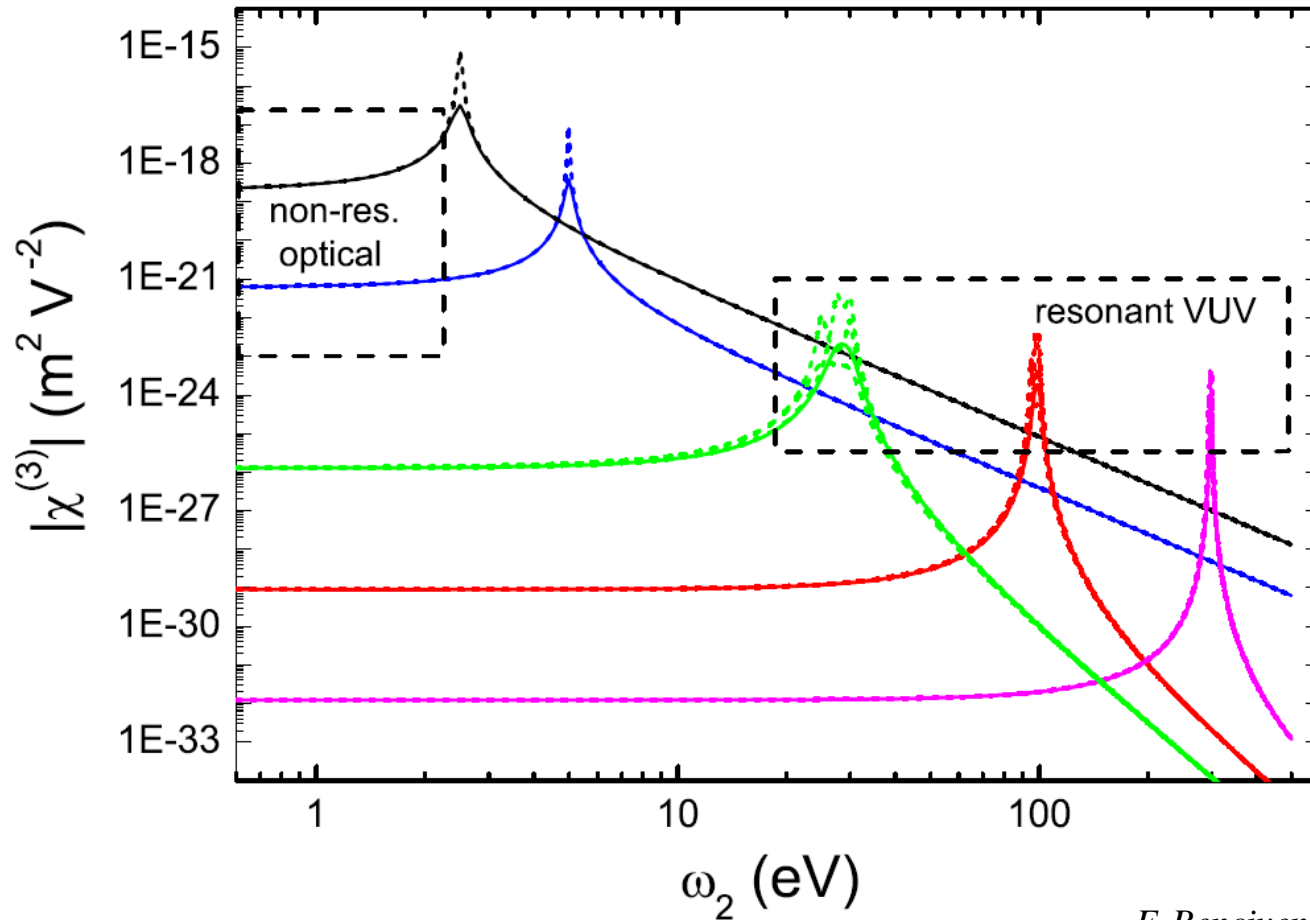

*F. Bencivenga et al., New. J. Phys. 2013*

# Energy - Momentum transfer region "Invasion"

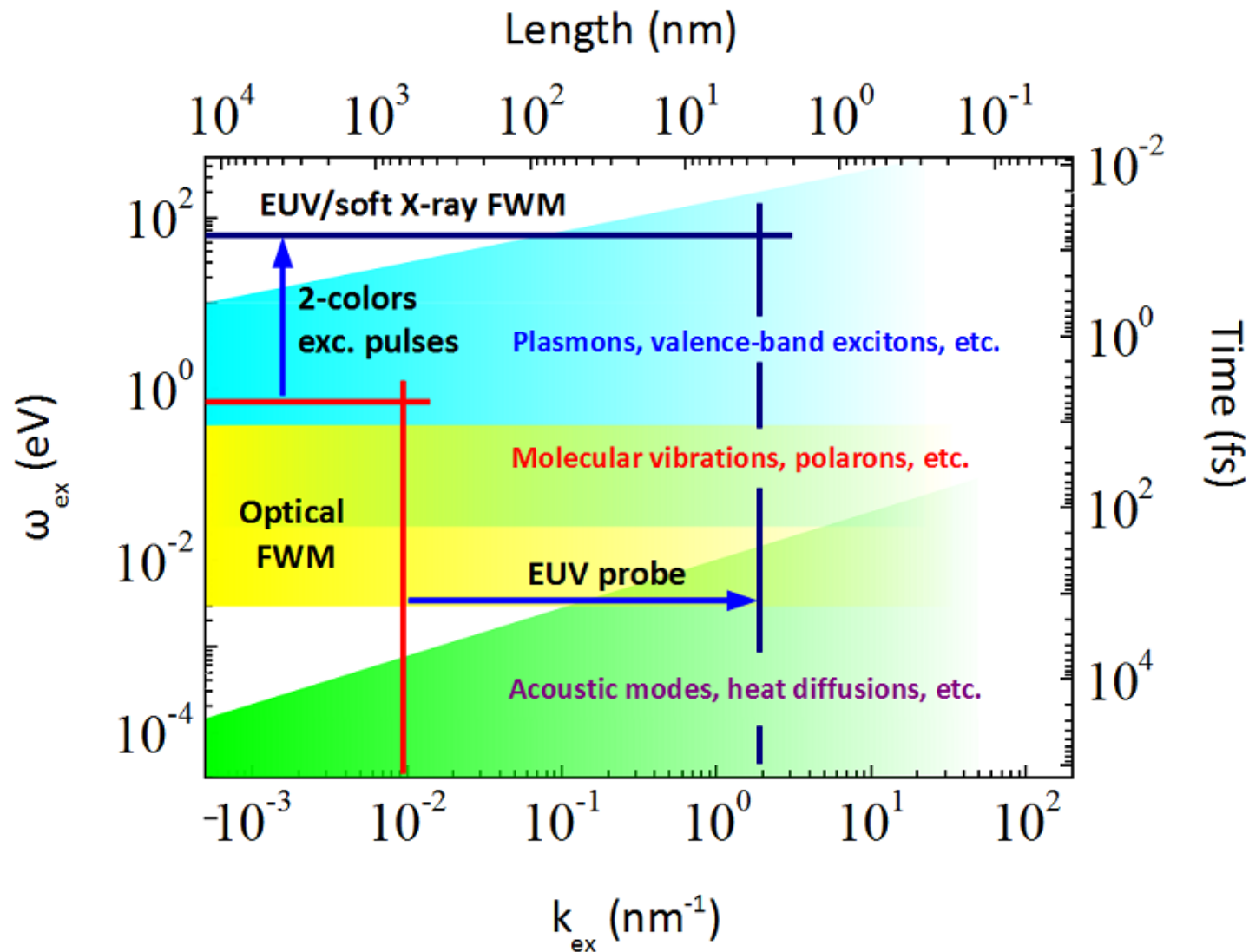

*F. Bencivenga et al., Adv. In Phys. 2015*

# Multiple pulse configurations

Multiple pulses can be generated by **double pulse seeding**

**Temporal separation** between 25-300 and 700-800 fs.

**Shorter separations** are accessible via FEL pulse splitting. *Mahieu et al. Optics Express (2013)*

Larger separations require the **split & delay line**.

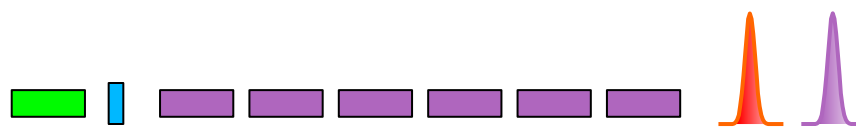
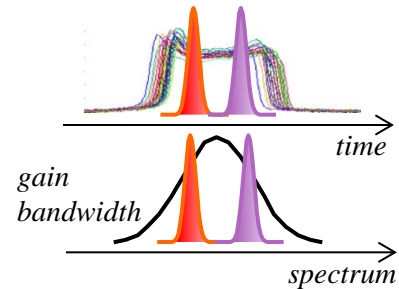

Spectral separation 0.4-0.7%  
(*E. Allaria et al., Nat. Comm 2013*)

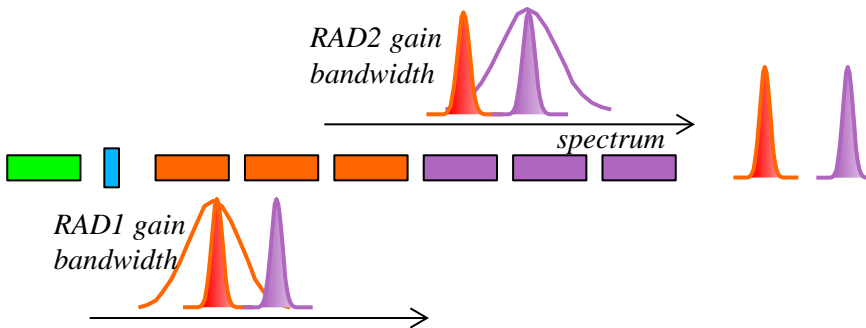
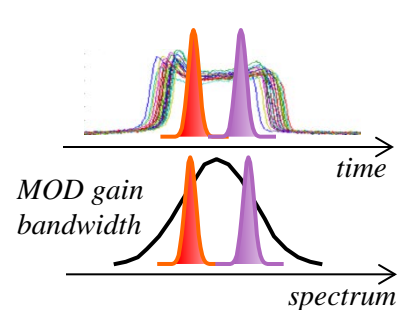

Spectral separation 2-3%  
or much larger if the two  
radiators are tuned at  
different harmonics  
(*Sacchi et al., in preparation*)

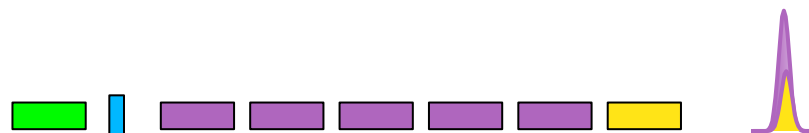
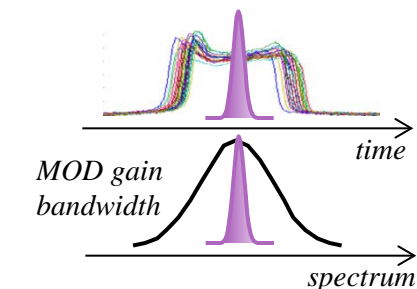

Two (almost) temporally  
superimposed pulses at  
harmonic wavelengths of the  
seed. They are correlated in  
phase that can be controlled  
with the phase shifter  
(*K. Prince et al., submitted*)

## Two-colour pump-probe experiments with a twin-pulse-seed extreme ultraviolet free-electron laser

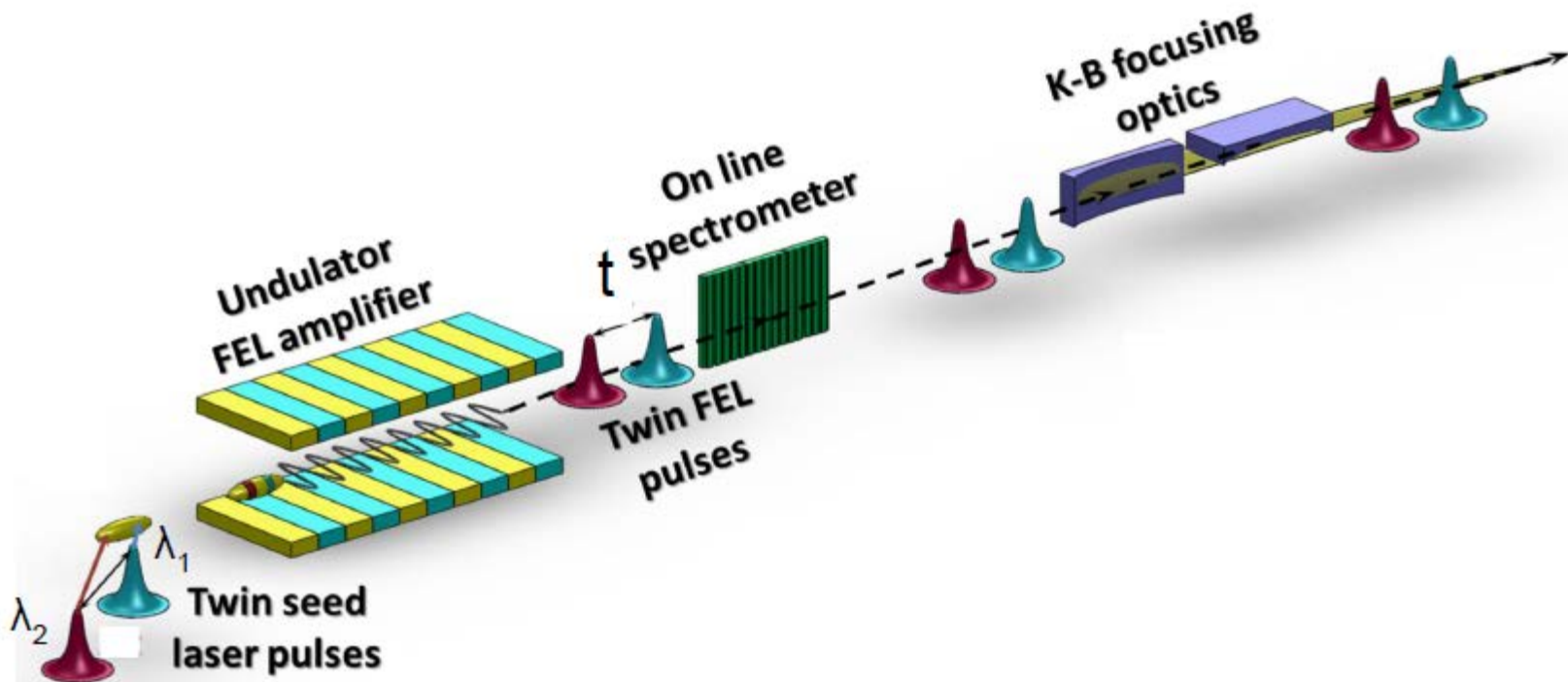

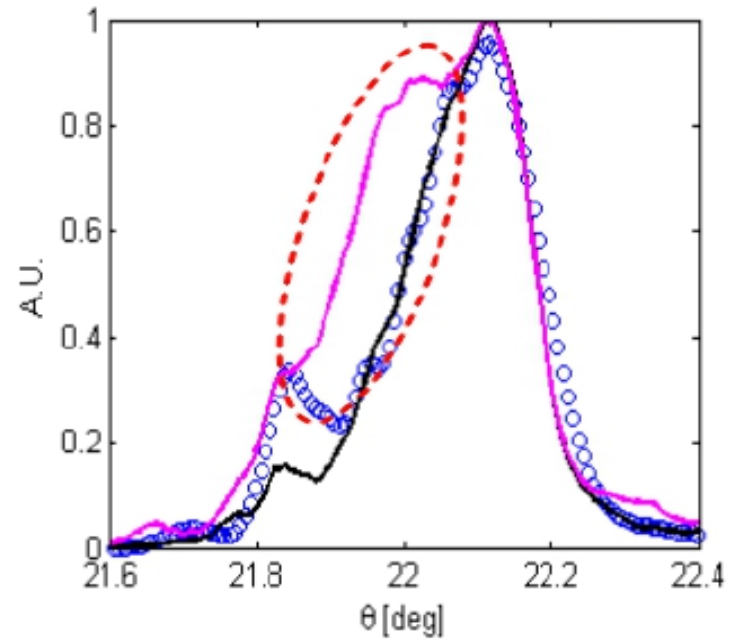
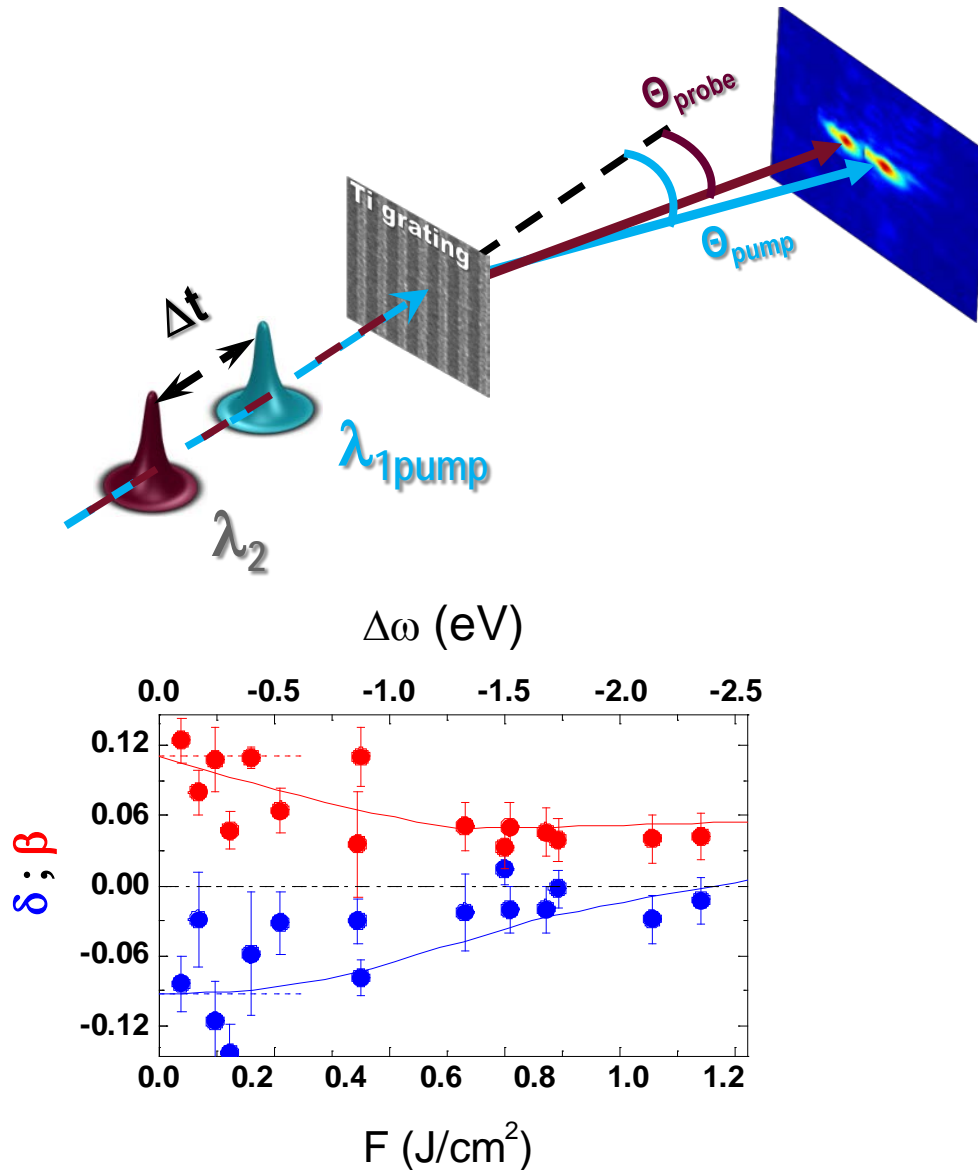

*F. Bencivenga et al., Farad. Discussion (2014)*



# Pump & Probe on Silicon

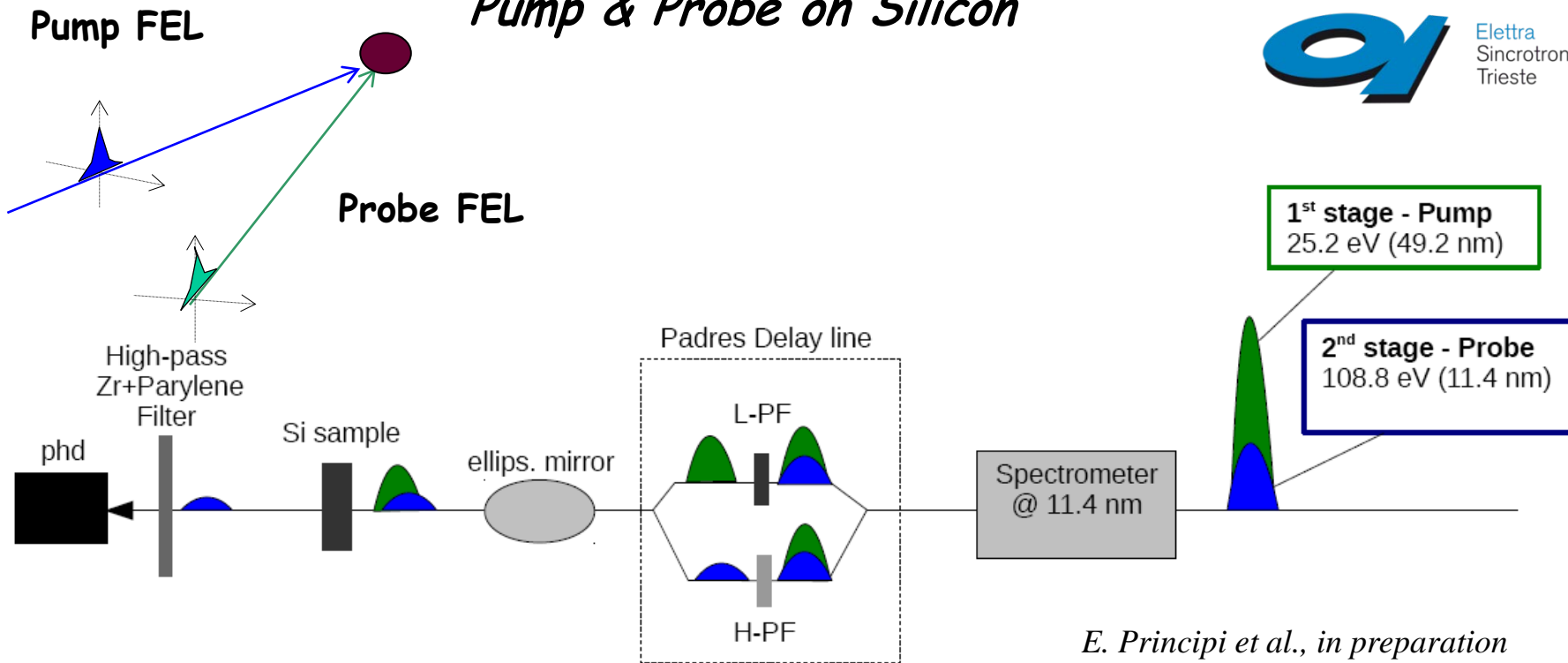

*E. Principi et al., in preparation*

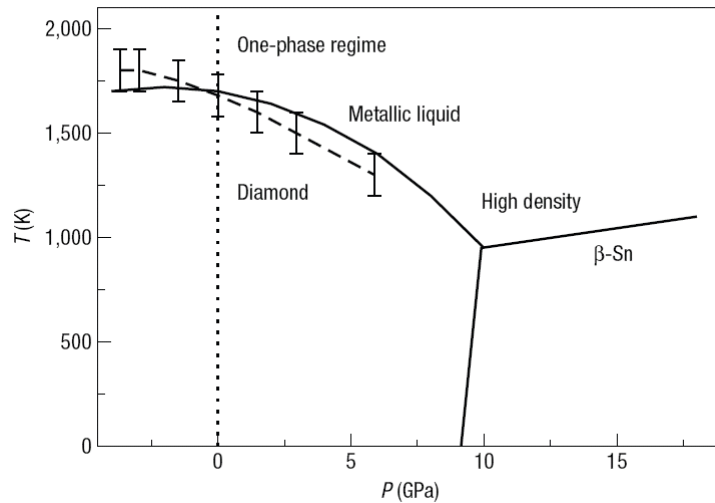

*P. F. McMillan et al., Nature (2005)*

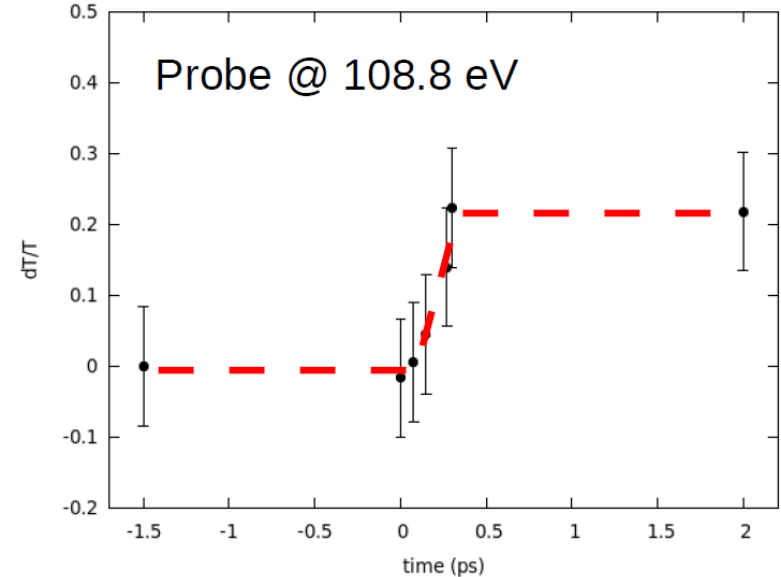

# Conclusions



*T. Scopigno*



*K. Nelson*



*M. Chergui*

- Charge transfer dynamics in **metal complexes**
- Charge injection and transport in **metal oxides nanoparticles**
- Vibrational modes in **Glasses**
- Charge **Density Wave**
- Quasiparticle diffusion (**Polarons**)
- Sound velocity in **Graphene**



*G. Knopp*



*A. Föhlisch*



*G. Monaco*

# Acknowledgments



*L. Giannessi*



*M. Danailov*



*M. Zangrando*



*M. Kiskinova*



*M. Manfredda*



*F. Capotondi*



*A. Battistoni*



*A. Gessini*



*E. Pedersoli*

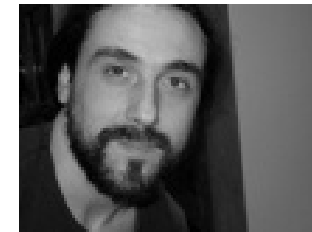

*R. Cucini*



*E. Giangrisostomi*



*F. Bencivenga*



*E. Principi*

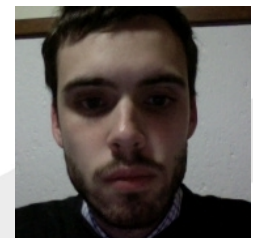

*R. Mincigrucci*

# SiN reflectivity

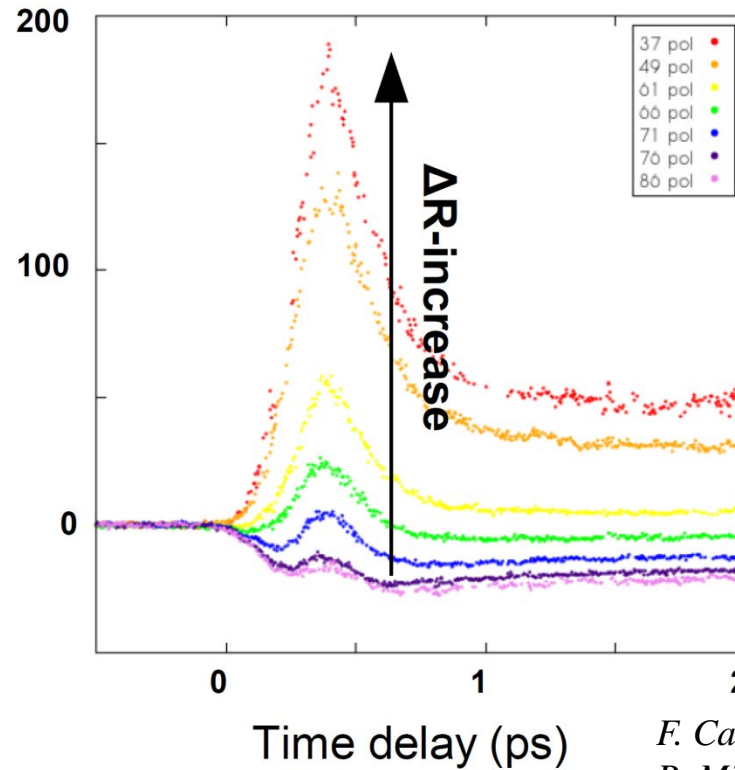
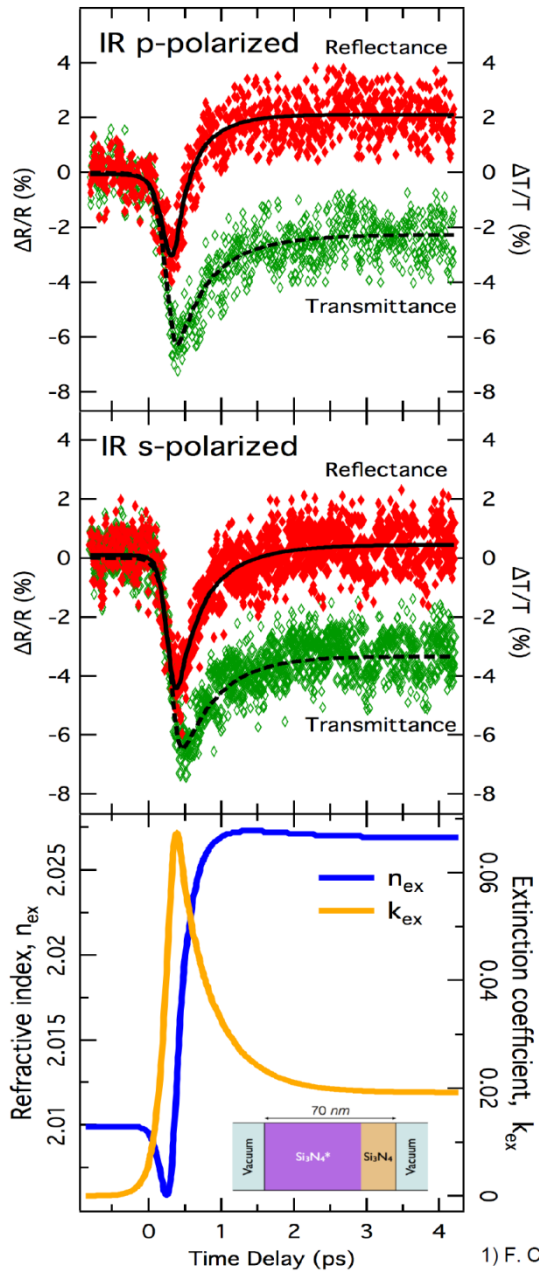

*F. Casolari et al., APL (2014)*  
*R. Mincigrucci et al., in preparation*

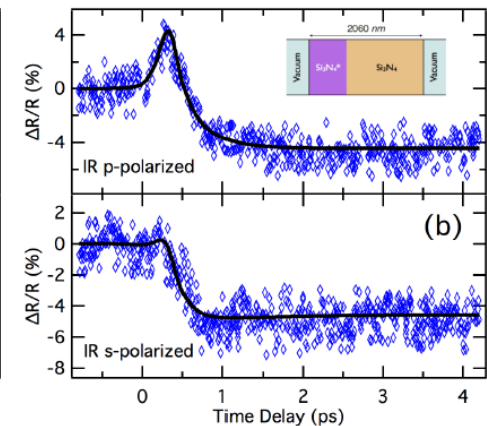
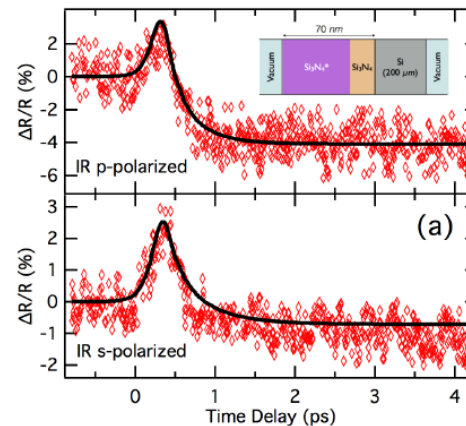

1) F. C.

