

The Performance & potential of an ATLAS-like HCAL Tile with si-PMs for FCC-hh Detector

Ana Henriques /CERN



Stockholm

8 November 2016

Outline

- The FCC-hh collider and detector concept
- The potential of an ATLAS-like Tile hadronic calorimeter with si-PMs readout for the barrel HCAL
- HCAL requirements at 100TeV
- Summary and next steps
-and the perspectives for ATLAS Tile HCAL with better granularity using multi-anode PMTS for HL-LHC

FCC-hh collider

- FCC-hh at CERN (CERN strong support)
- $\sqrt{S} = 100 \text{ TeV}$ (x 7 LHC)
- 100 Km tunnel
- e^+e^- (FCC-ee) as intermediate step
- $p-e$ (FCC-he) option
- Similar project in China (SPPC)

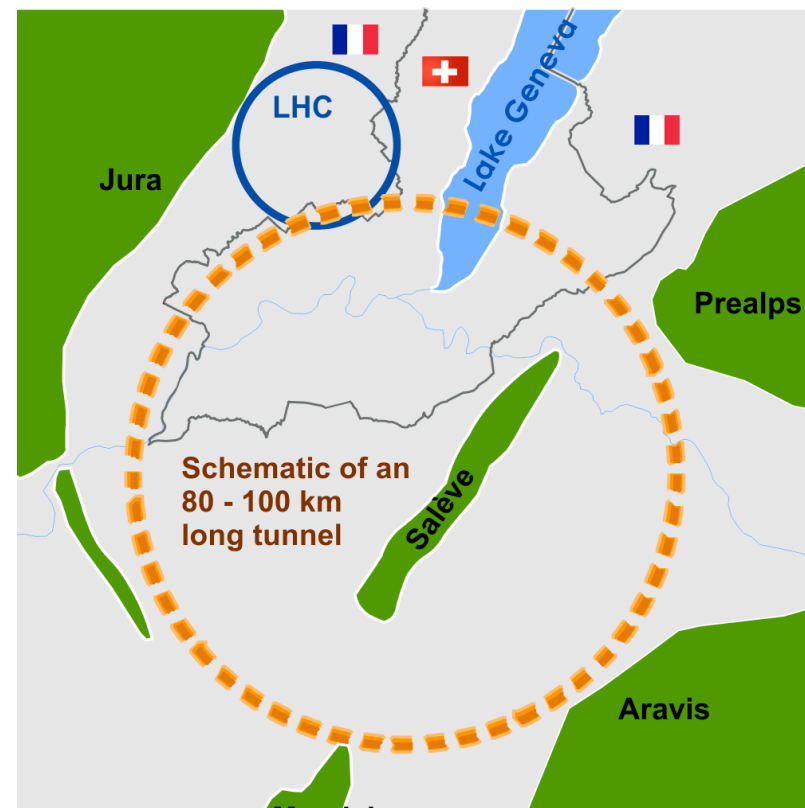

FCC-hh	Phase 1 (10 yrs)	Phase 2 (15 yrs)
C.M. Energy (TeV)	100	100
Luminosity ($\text{cm}^{-2}\text{s}^{-1}$)	5×10^{34}	30×10^{34}
Int. Luminosity (ab^{-1}) *	2.5	15
Bunch spacing (ns)	25	25 (5)
Pile-up (per BX)	170	1024(204)

* 5yrs cycles (3.5 years operation + 1.5 years shutdown)



FCC Timeline

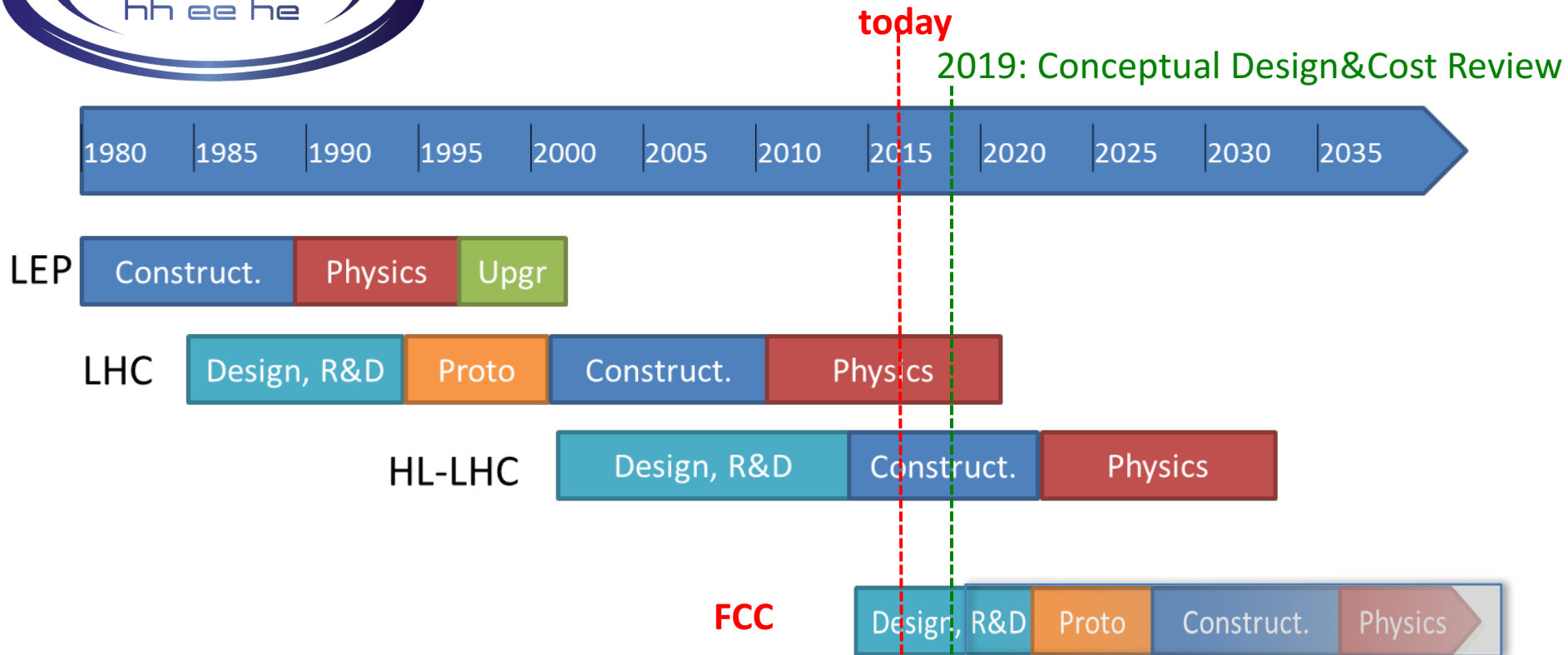

- HL-LHC operation until ~2035
- Now developing FCC collider and detector concepts to be ready after HL-LHC (~2036)

FCC-hh Detector

(baseline Rome FCC workshop April 2016)

Barrel HCAL: $\sigma_E/E \sim 50\%/\sqrt{E} \oplus 3\%$
better granularity than ATLAS/CMS

Muon Chambers:
inside twin solenoid

Central Magnet:
Twin Solenoid
6T, 6m radius

Tracker: $\sigma_{pt}/pt \sim 10\%$
at 10 TeV (2.5m radius)

Barrel ECAL: $\sigma_E/E \sim 10\%/\sqrt{E} \oplus 1\%$
better granularity than ATLAS/CMS

Fwd Magnets:
dipoles 10Tm

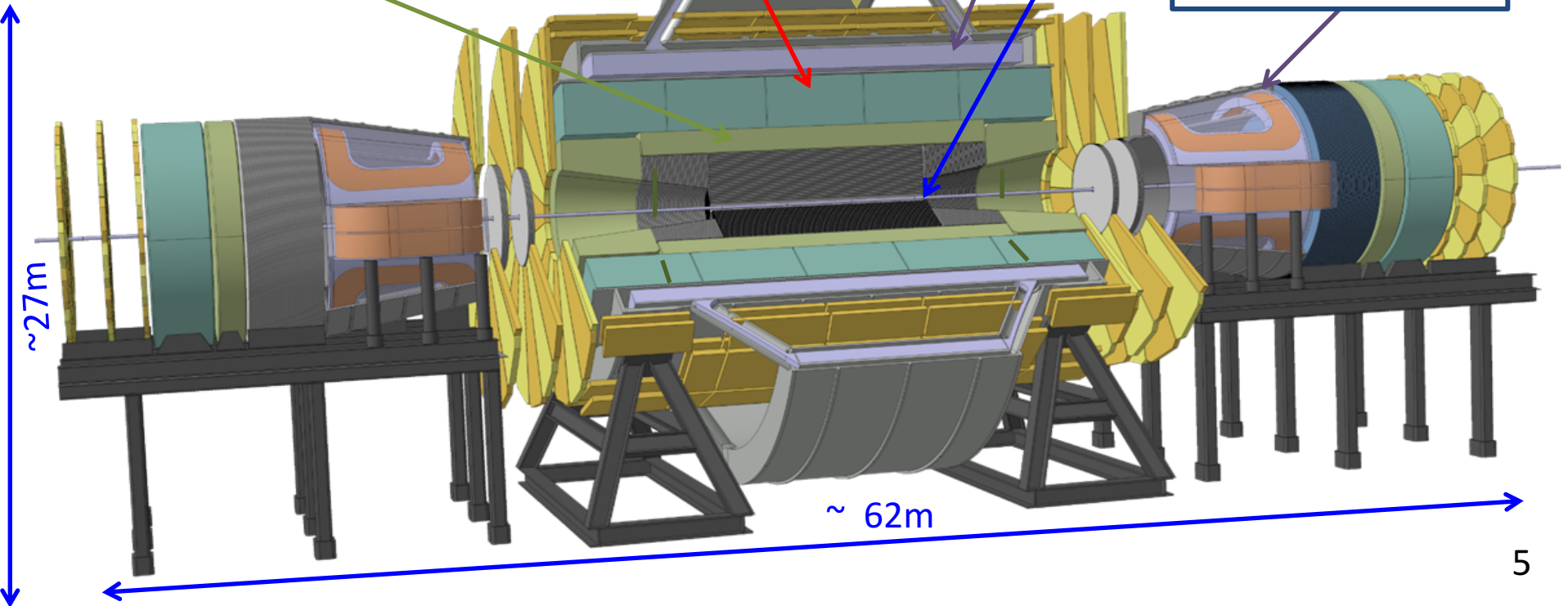

The role of HCAL & requirements at FCC-hh

- Expect large energy of decay products
 - Large jet p_T
 - Missing ET signatures
 - High-mass, long-lived particles
 - Tau decays
 - Veto on photons / electrons / jets
- Requirements for HCAL
 - **Containment**
 - **Resolution**
 - **Segmentation**
 - η Coverage
 - Dynamic range
 -

QCD jets at a 100 TeV collider

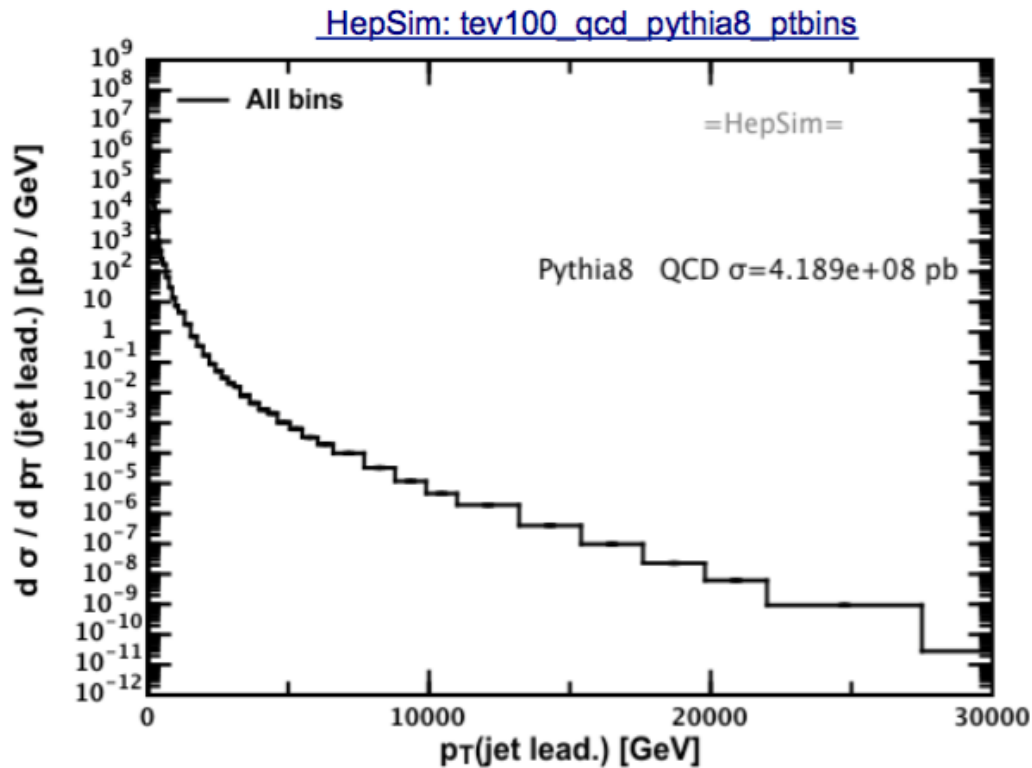

Expect very high- p_T events!
 Typical benchmark used is q^*
 because of its high cross section
 Example: $q^* (40 \text{ TeV}) \rightarrow qq$

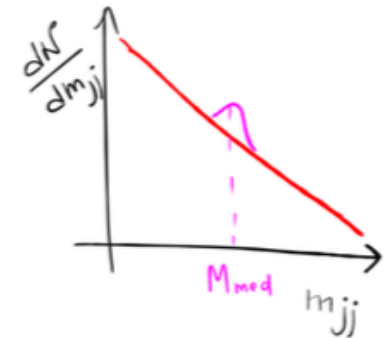

10 ab^{-1} :
 a dozen of events are expected for $p_T(\text{jet}) > 20 \text{ TeV}$ at LO QCD

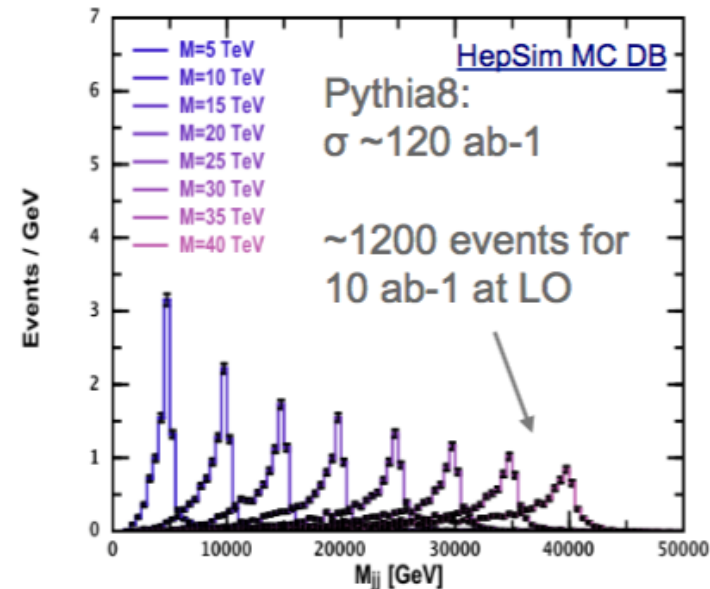

Jets p_T [TeV]	1	5	10	20	30	40
Cross section [pb]	3453	0.974	0.0108	$1.84e^{-5}$	$3e^{-8}$	$3.4e^{-12}$

C.Helsens

Effect of HCAL energy resolution on dijet resonances

40 TeV $q^* \rightarrow jj$

C. Doglioni

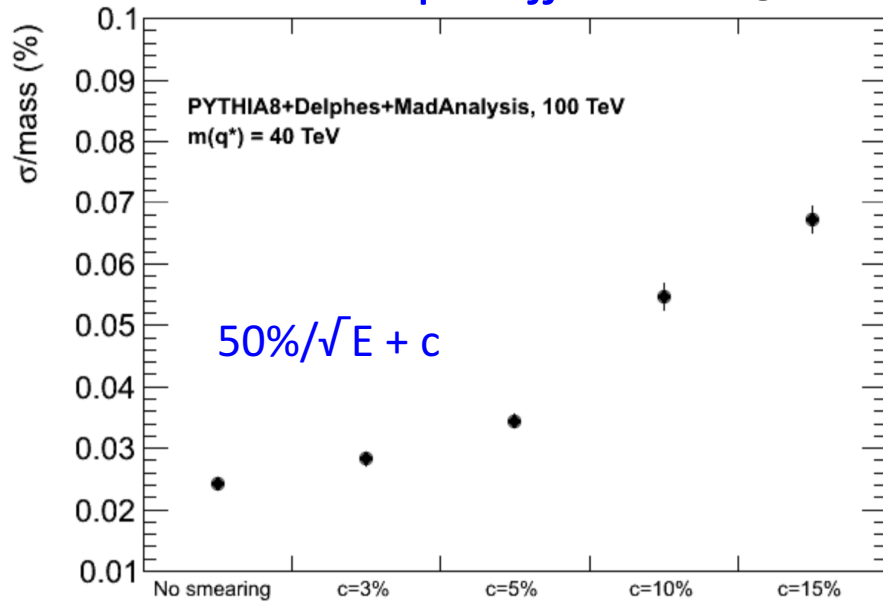

HCAL resolution constant term C

$Z' \rightarrow jj$

R. Torre

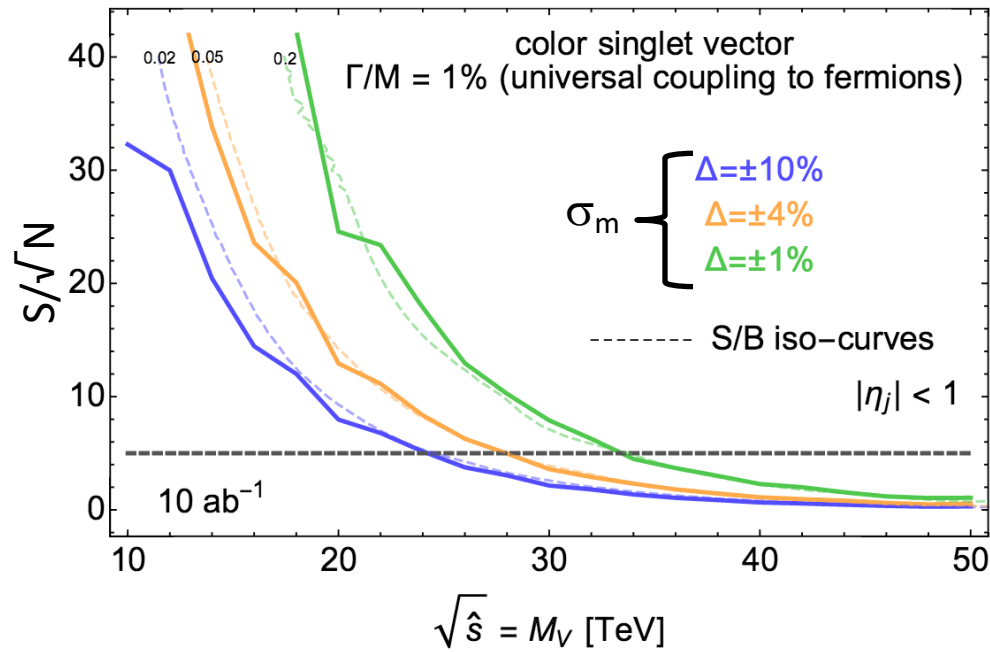

Jet resolution $\sim 2\text{-}3\%$ needed for multi TeV dijet resonances

- Extend $Z' \rightarrow jj$ discovery potential by 10 TeV between $\sigma_m = 10\%$ to 1%
- Constant term will dominate at TeV energies ($\sigma/E = a/\sqrt{E} \oplus c$)
- Good shower containment is mandatory!

Reconstruction of highly boosted heavy objects (Higgs, W, Z, top, Z')....

S. Chekanov et al.

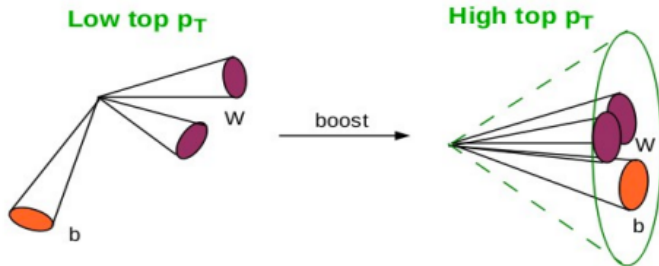

Jet substructure reconstruction \rightarrow better calo granularity

Boosted top quarks

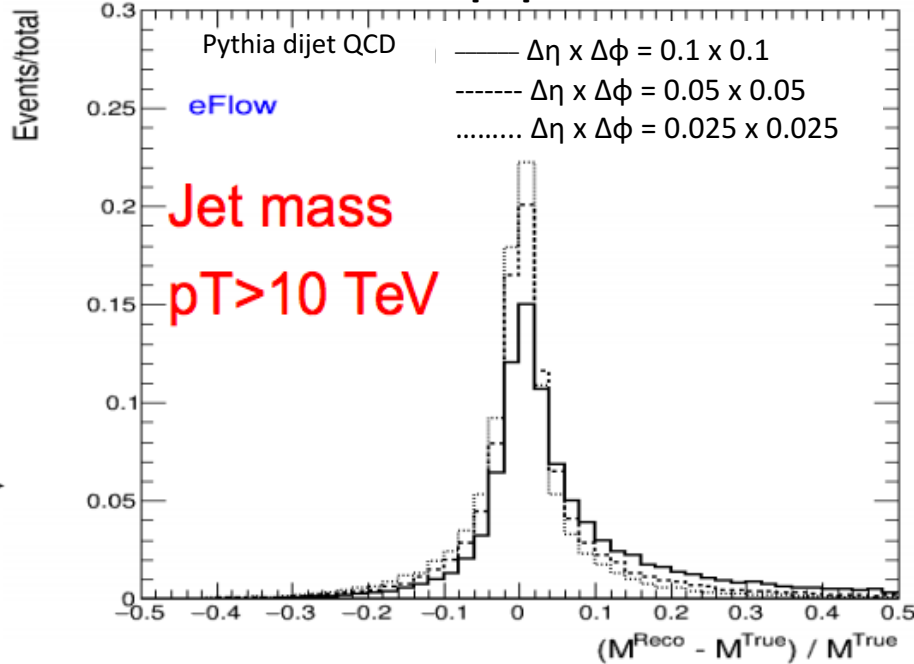

$K^0_L \rightarrow 2$ neutral hadrons

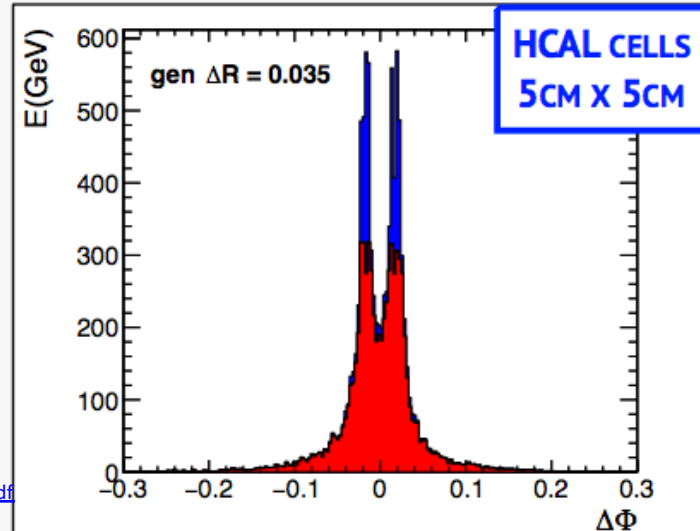
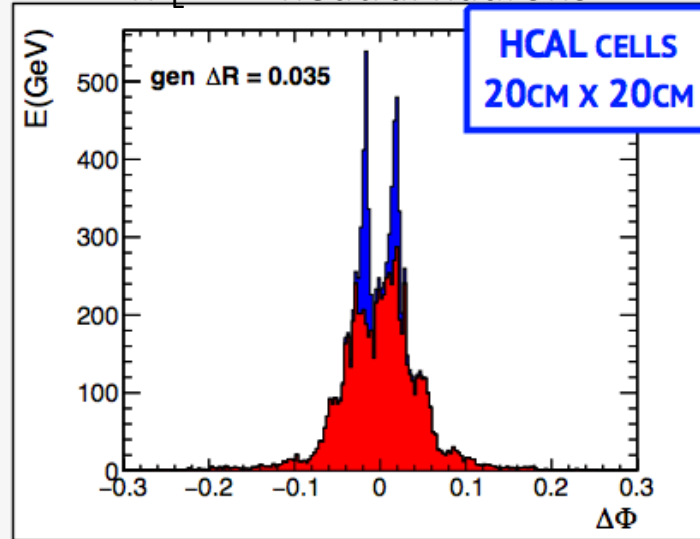

https://indico.cern.ch/event/382815/contributions/910644/attachments/1139429/1666195/PhysicsRequirementsHCAL_boost2015.pdf

<https://indico.hep.anl.gov/indico/getFile.py/access?contribId=4&resId=0&materialId=slides&confId=1047>

Need at least 2-4 times better granularity than ATLAS/CMS $\Delta\eta \times \Delta\phi = 0.1 \times 0.1 \rightarrow 0.025 \times 0.025$

η coverage needs for calorimetry and tracking

- Coverage up to $\eta \sim 6$ for vector boson fusion (VBF) production and WW scattering physics.

H production in gluon gluon fusion (ggF)

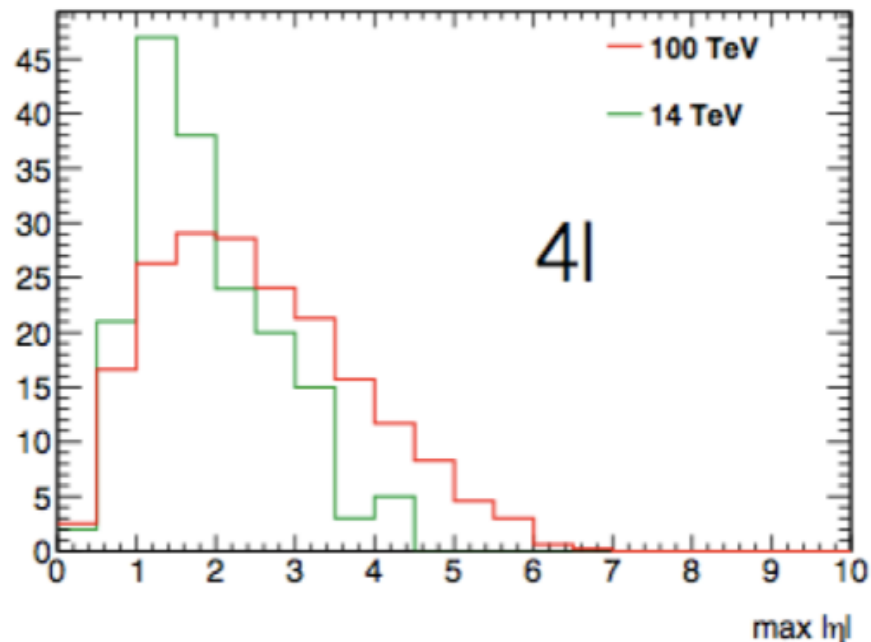

C. Helsens

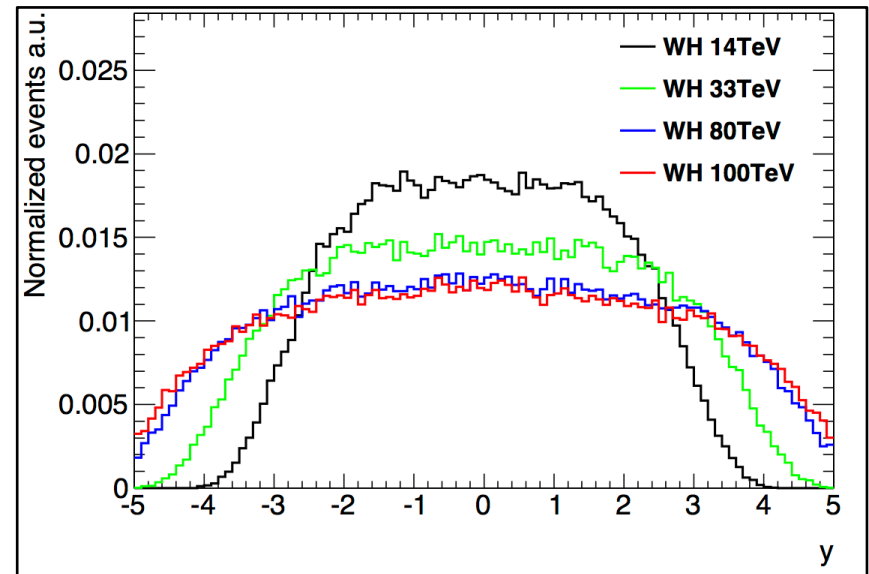

The potential of an *ATLAS*-like Tile hadronic calorimeter with si-PMs readout for the central HCAL in FCC-hh ($\eta < \sim 1.7$)

ATLAS Tile Calorimeter ($|\eta| < 1.7$)

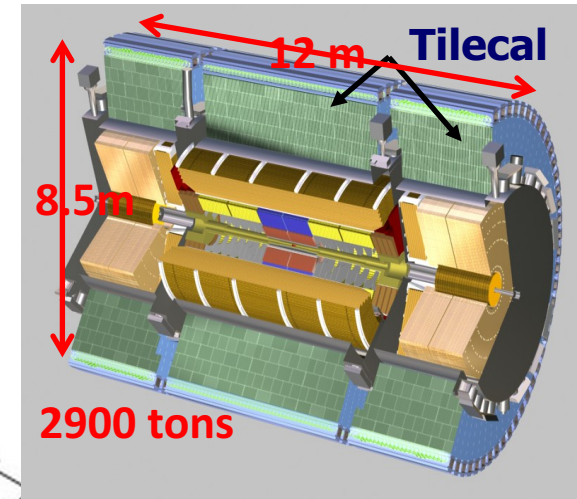

- Scint. Tiles; fibres parallel to incoming particles at $\eta=0$
 - Steel/Tiles: = 4.7 : 1 ($\lambda = 20.7$ cm)
 - ~ 620 k fibres; ~ 400 k Tiles; ~ 10 k channels
 - optics granularity 50 times better than readout !
 - 7.7λ at $|\eta|=0$; (9.7λ with the ECAL)
 - $\Delta\eta \times \Delta\phi = 0.1 \times 0.1$
 - 3 longitudinal layers (11 were possible...)
 - $e/h \sim 1.3$

- Pion resolution (test beam):

- $\sigma_E/E \sim 52\%/\sqrt{E} \oplus 5.7\%$ (7.9λ)
- $\sigma_E/E \sim 45\%/\sqrt{E} \oplus 2\%$ (9.2λ)

Target at ATLAS (with EMCAL):

- Jet $\sigma_E/E \sim 50-60\%/\sqrt{E} \oplus 3\%$
- Containment $\sim 98\%$ TeV hadrons, jets

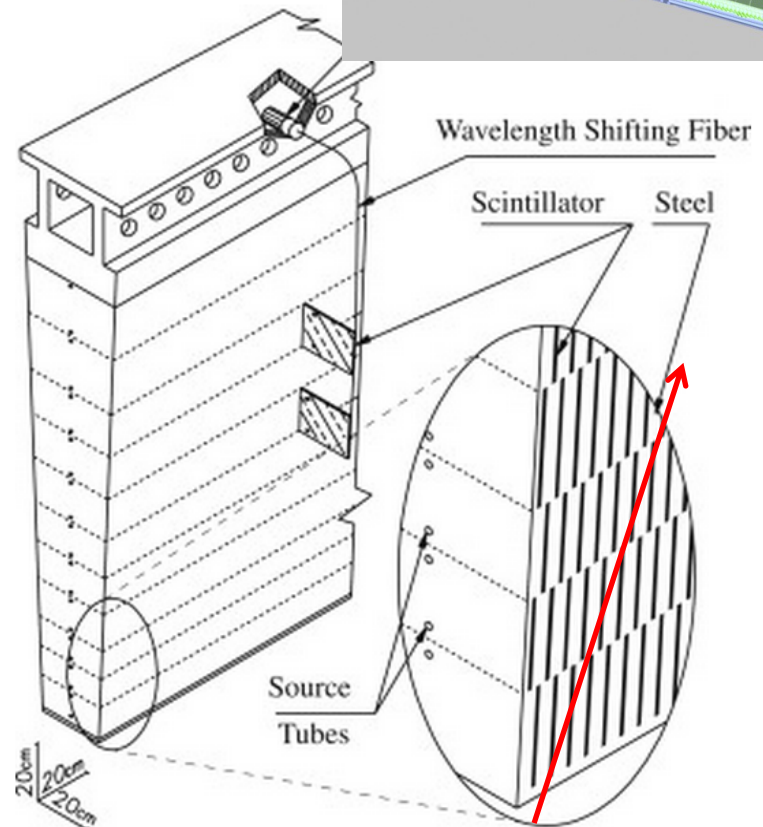

ATLAS TileCal optics/granularity

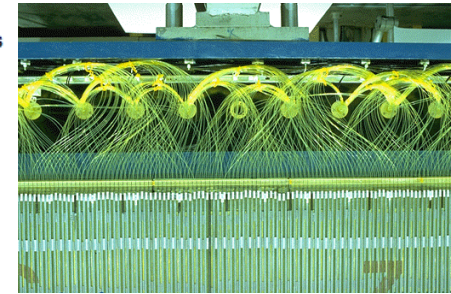
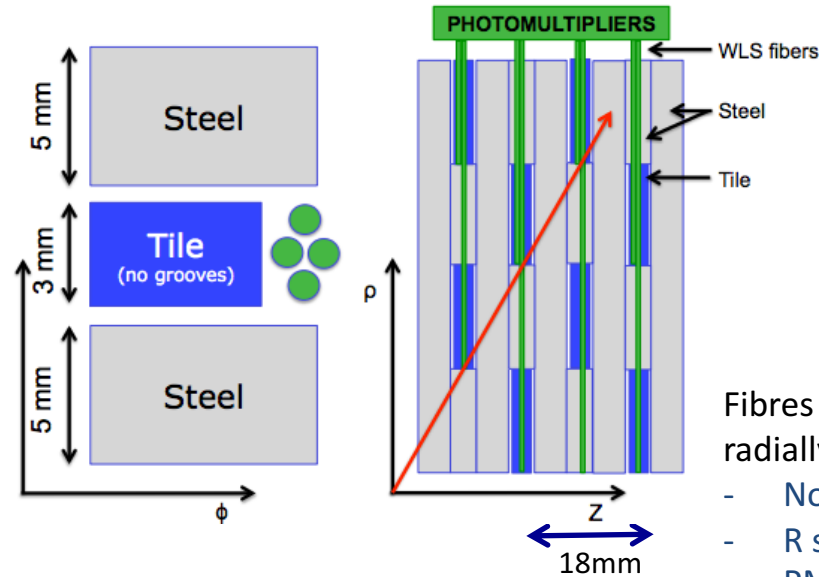
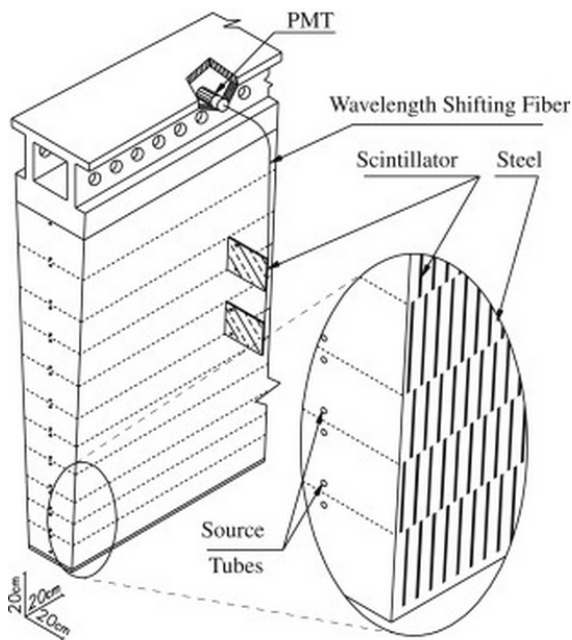

Fibres start at different R and go radially out =>

- No ϕ cracks
- R segmentation
- PMTs at outer Radius

- Minimal changes in optics/mechanics to exploit full granularity at FCC-hh

- ATLAS reading out all tiles
- $\Delta\eta$: 3mm tiles every 9-18mm in Z
 - $\Delta\eta$ (optics) $\sim 0.1/(50-100)$
- ΔR : 11 tiles and 8 fibres in R
 - 8-11 layers with $1\lambda < \Delta R < 0.5\lambda$
- $\Delta\Phi$: 20 cm tiles
 - $\Delta\phi = 0.1$ (dual fibre readout)

Si-PMs (CMS upgrades, ILC, CLIC,...)

8 ch Array package w/ 4 fiber/ch readout

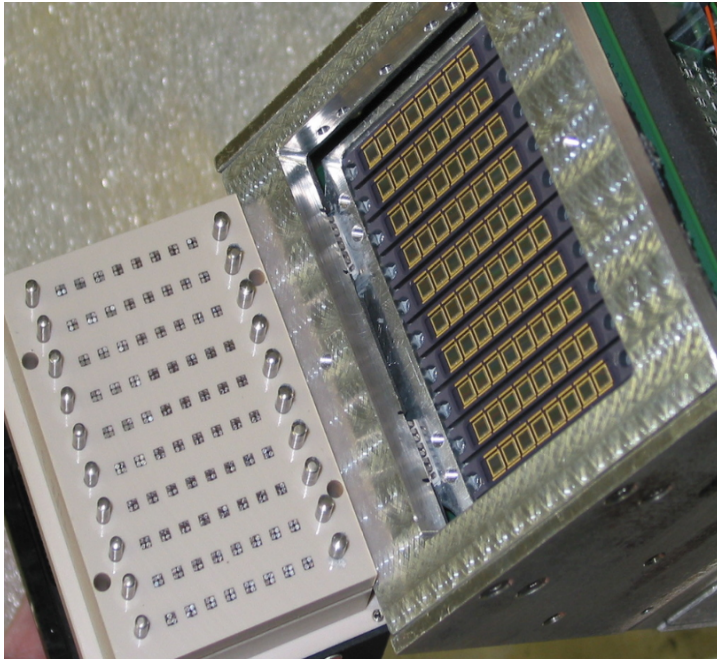

18 ch Array package for single fiber readout

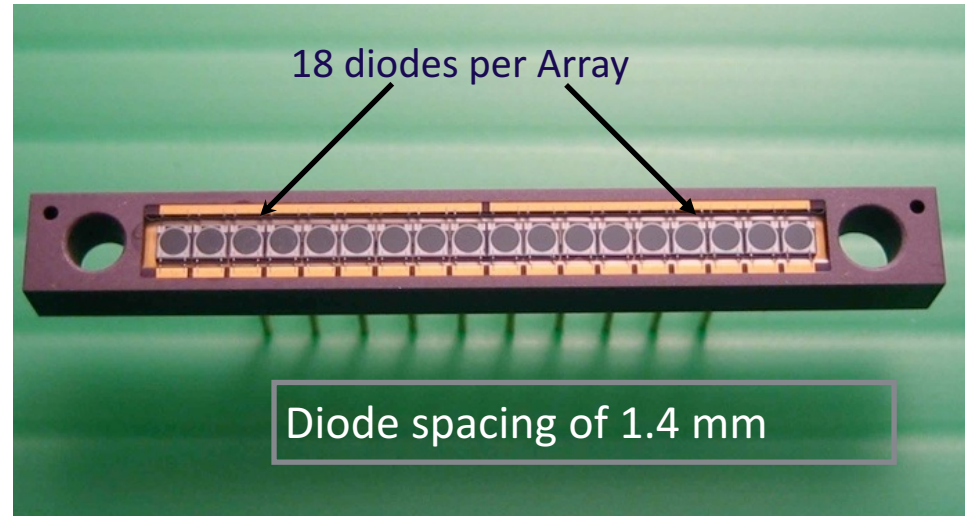

Advantages for FCC-hh:

- $<$ space at R_{out} (no fibre bundles needed)
- insensitive to B field
- Can read each fibre
- Faster response
- Radiation levels ok at outer radius

$R_{out} \sim 30\text{cm}$
($\sim 1.5 \lambda$)

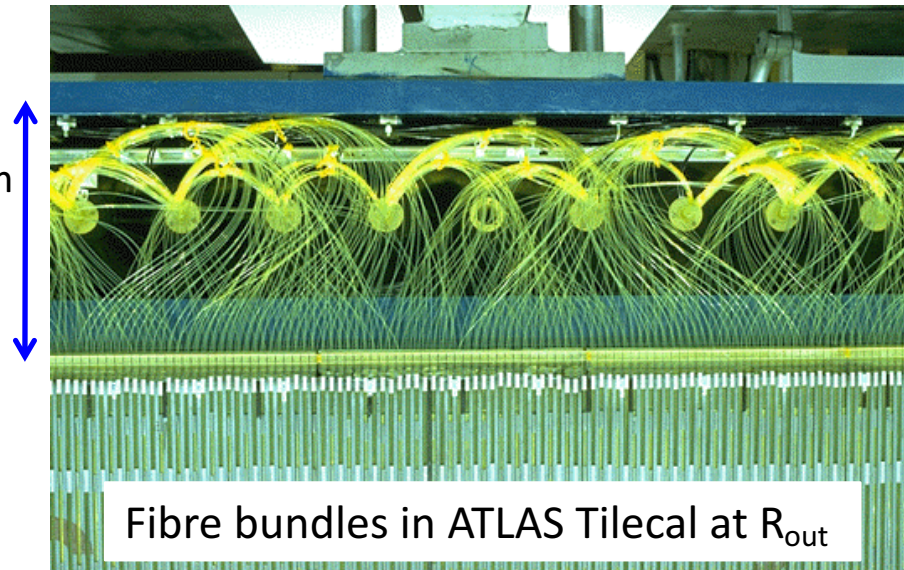

Changes needed for FCC-hh .vs. ATLAS

- Steel-> Stainless steel (solenoid=> B field in HCAL) , no W,Pb:
 - faster hadronic showers (less neutrons)
 - Less muon scattering/tails
- Redesign outer support:
 - Reduce thickness (ATLAS ~ 30 cm; 1.5λ)
 - Optimize electronics location/space (no need to shield Si-PMT)
 - Optimize fibres to Si-PMTs coupling
- Improve ϕ granularity to $\Delta\phi = 0.025$ (or less)
 - ~ 120 modules in ϕ
 - half trapezoidal tiles with single WLS fibre readout
- Increase HCAL to 10λ (ECAL+HCAL $\sim 12\lambda$)
- Cesium calibration already sees each Tile
 - (~ 20 km pipes in ATLAS, 0.3% precision).

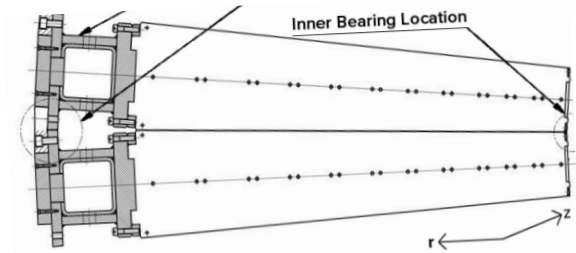

64-> 120 modules; bigger Rin ; thinner outer surface

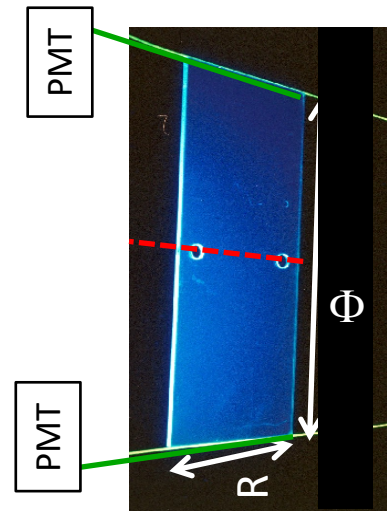

Trapezoidal tiles-> $\frac{1}{2}$ tiles + single fibre readout

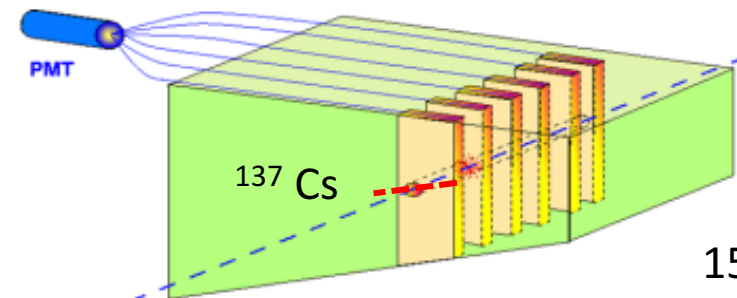

^{137}Cs source for inter-calibration and drifts over time unchanged

Mechanics Layout

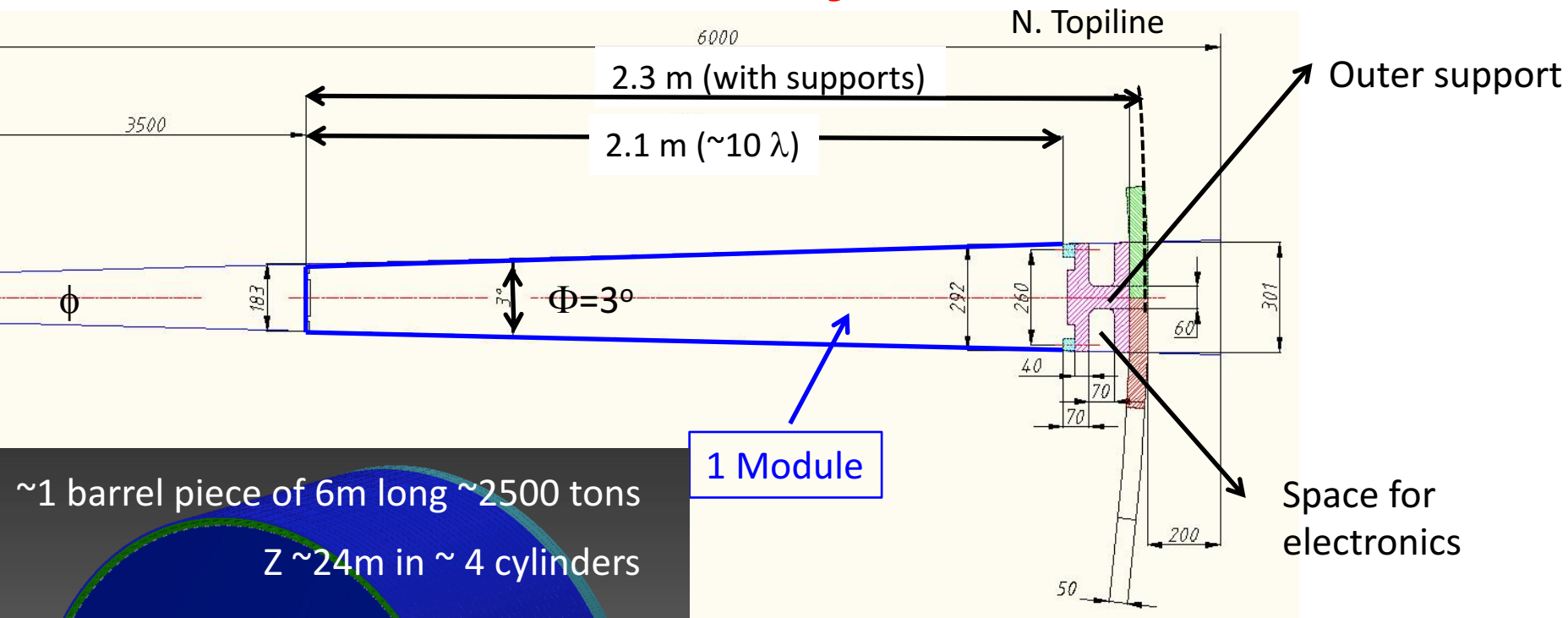

~ 1 barrel piece of 6m long ~ 2500 tons
 $Z \sim 24$ m in ~ 4 cylinders

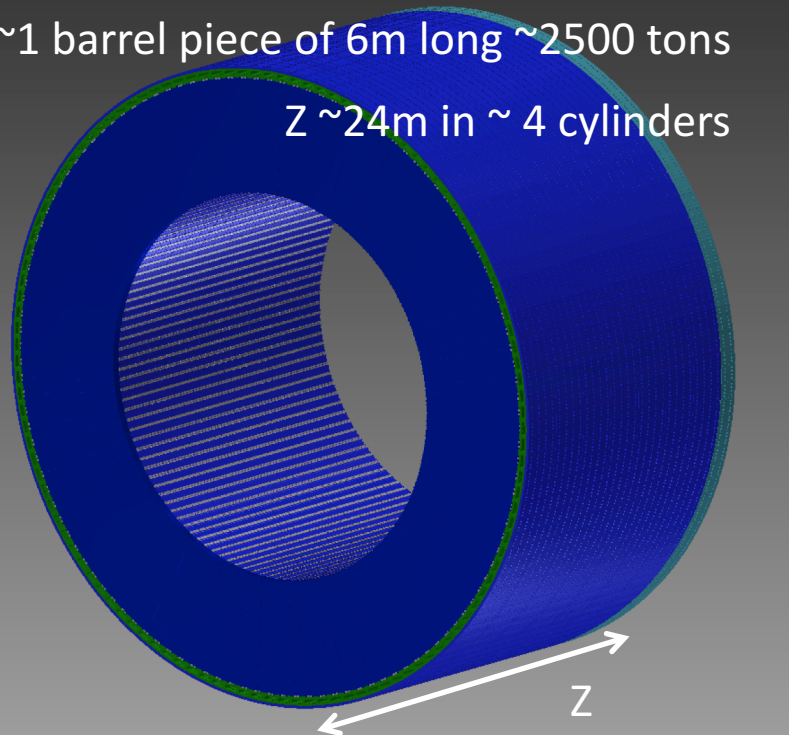

- 120 modules in ϕ ,
 ~ 2 times better than ATLAS
- Shorter outer mechanics supports
- Depth HCAL active cells
 $\sim 10 \lambda \rightarrow \sim 2$ m (+29% than ATLAS)
- $\sim 10\,000$ tons (in ~ 4 cylinders of 6m in Z)

FCC-hh Radiation levels for 30 ab⁻¹ (Fluka)

M. I. Besana

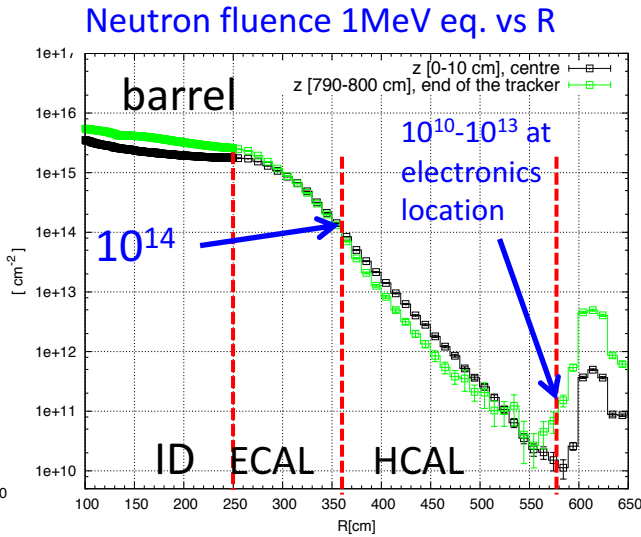
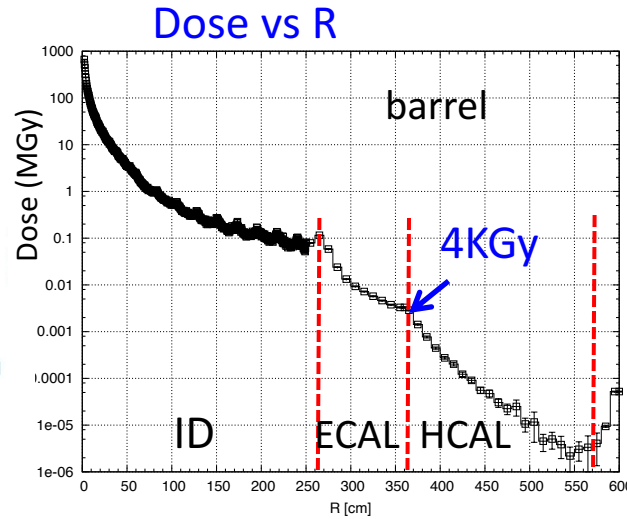
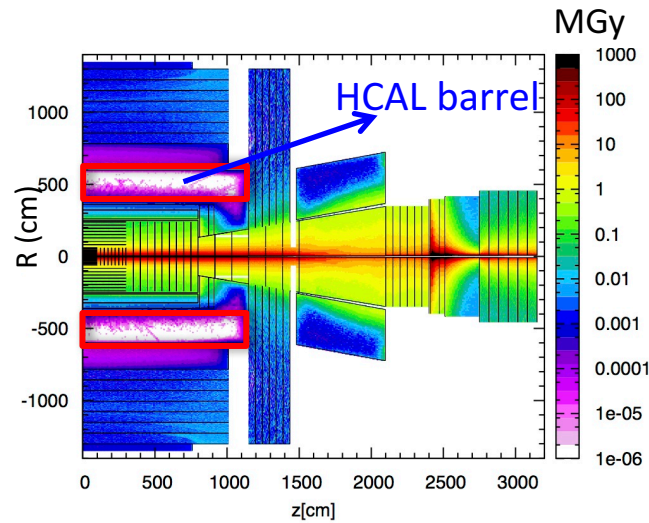

- In barrel HCAL max levels for 30 ab⁻¹:
 - 4KGy (=400 krad)
 - 10¹⁴ (10¹⁰-10¹³ at electronics location)
 - W/ ATLAS optics => -25% (still ok!)
- Today's materials more radiation hard
- Organic scintillators in HCAL barrel is safe, even if tracker will be shortened by 1m.
- More rad. hard technologies needed in HCAL end-cap and fwd (0.4MGy in EndCap ; 4 GGy in fwd HCAL...)

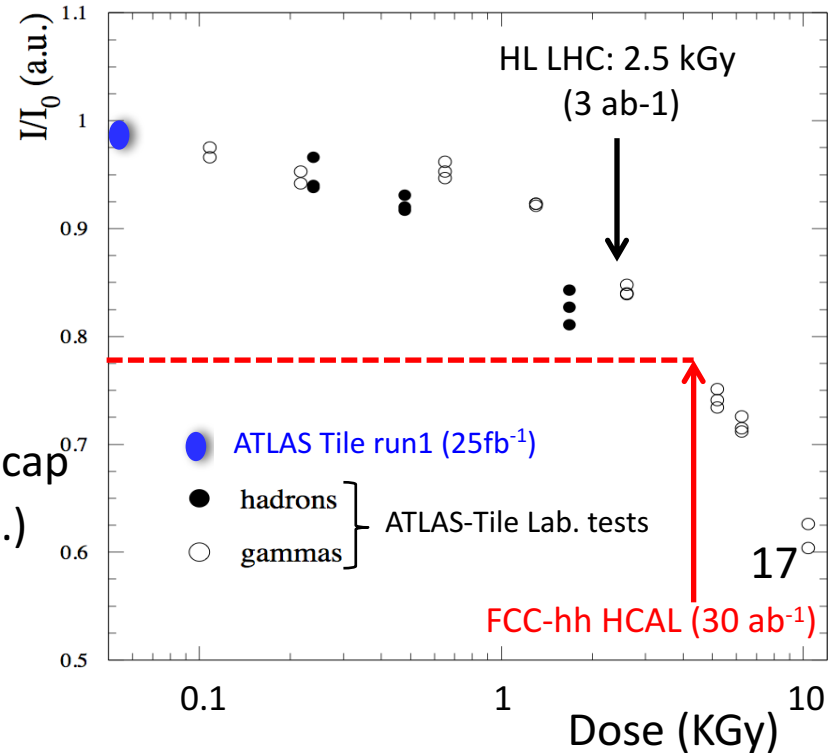

HCAL Performance requirements at 100TeV

From JINST paper: 2016_JINST_11_P09012.

<http://dx.doi.org/10.1088/1748-0221/11/09/P09012>

Single hadron content in multi-TeV jets

<https://arxiv.org/pdf/1604.01415v2.pdf>

C. Helsen

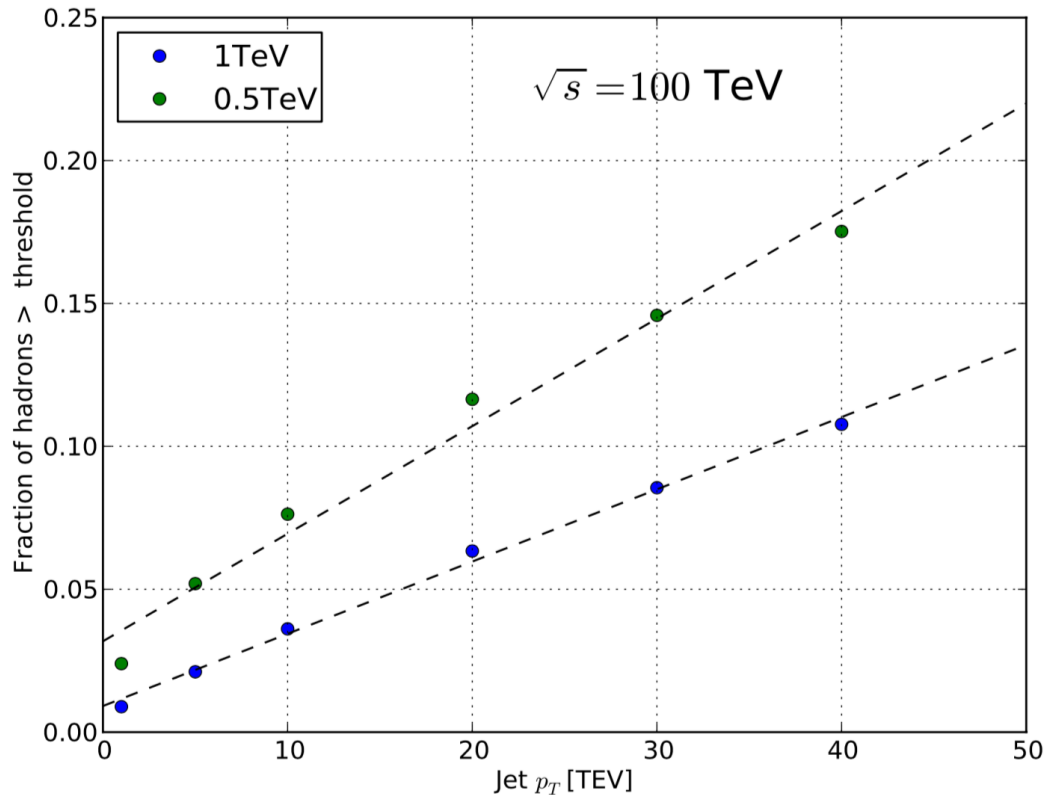

- For jets $p_T > 30$ TeV, $\sim 10\%$ of hadrons with $E > 1$ TeV (~ 9 hadrons/jet)
- What is the depth needed to contain at 98% few TeV single hadrons?

Single Pion Simulation

Geant4 + FTFP_BERT + Tile ATLAS model

C. Solans

<https://arxiv.org/pdf/1604.01415v2.pdf>

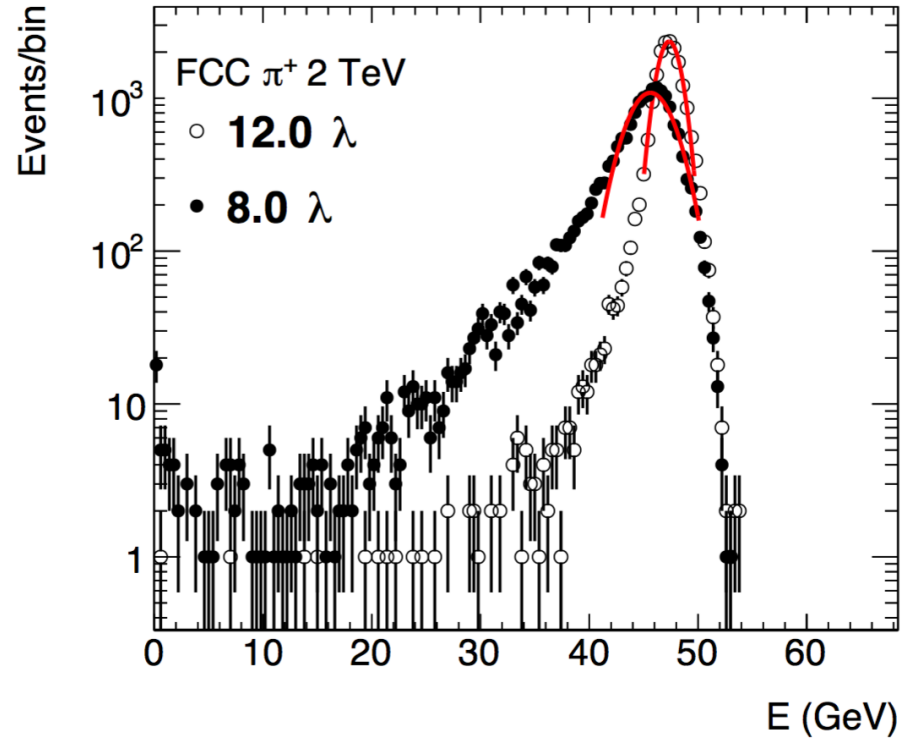
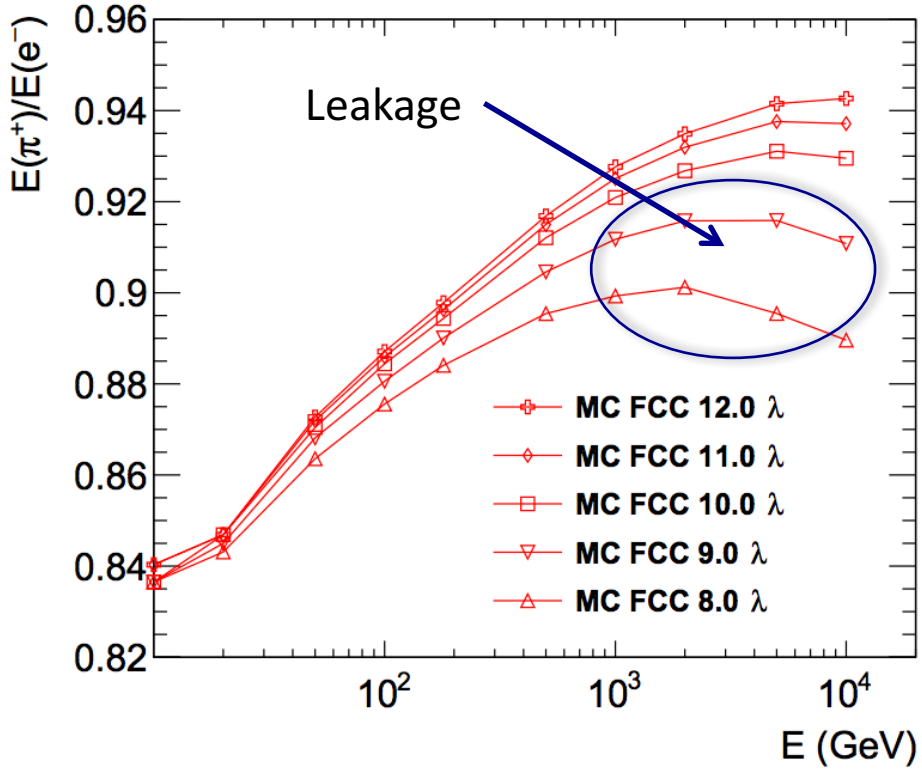

- Non compensating calorimeter ($e/h \sim 1.33$)
 - Implies non linearity for pions over energy
- Leakage enhances low energy tails and non-linearity
 - Response of 2 TeV pion: $8\lambda/12\lambda = 96\%$, $10\lambda/12\lambda = 98\%$
 - Percent of events below 3 sigma for $8\lambda = 11\%$, $12\lambda = 3\%$

Single Pion Containment

π parameterization 98% containment:

$$\lambda_{98\%} = \mathbf{a} \cdot \ln(E) + \mathbf{b}$$

<https://arxiv.org/pdf/1604.01415v2.pdf>

Method	Data		Simulation	
	a (λ/GeV)	b (λ)	a (λ/GeV)	b (λ)
Mean	0.95	4.7	0.64	5.4
Peak	0.74	4.2	0.75	3.8

Geant4 + FTFP_BERT + Tile ATLAS model

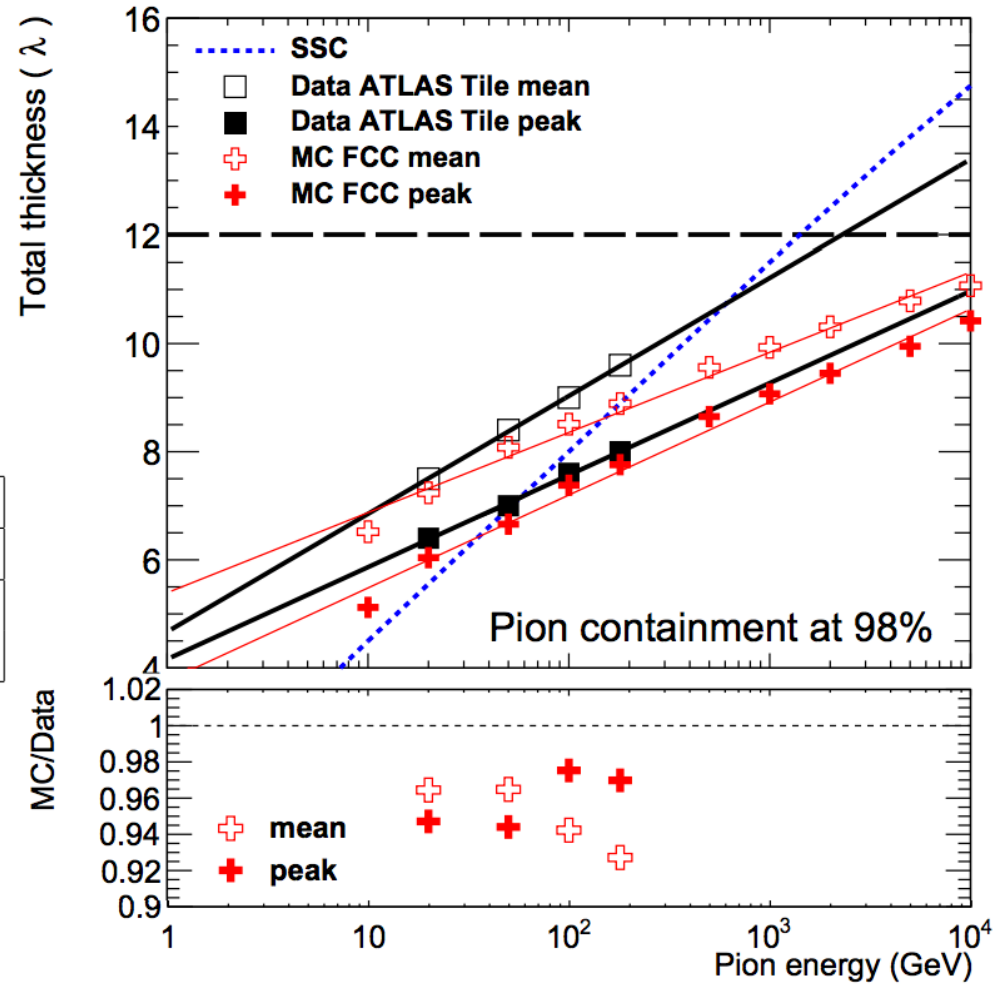

- $\sim 12 \lambda$ to contain few TeV single hadrons
- MC showers are $\sim 5-10\%$ shorter than data

Jet Containment

Jet containment at 98% :

$$\lambda_{98} = a \cdot \ln(p_T) + b$$

	Simulation	
Method	a (λ/GeV)	b (λ)
Mean	0.495	6.3
Peak	0.615	4.7

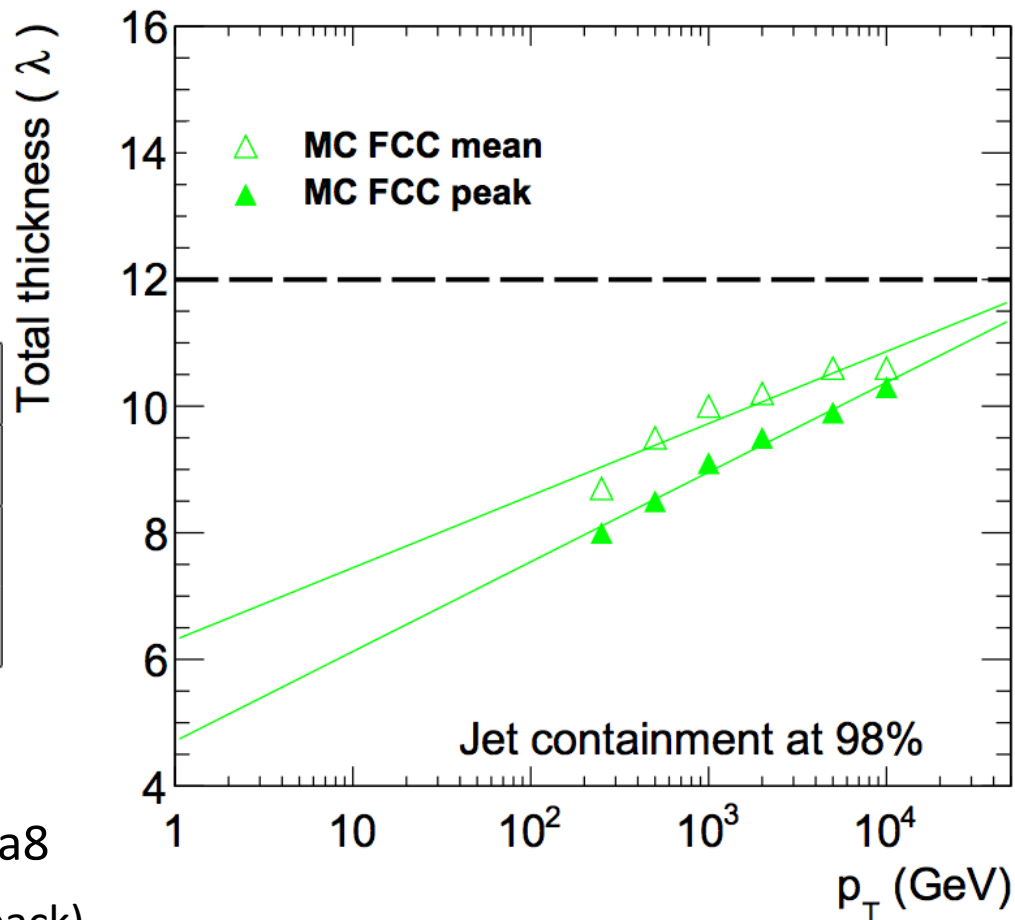

- Fixed p_T parton hadronized in Pythia8
 - Simulated $Z' \rightarrow qq$ at rest (back to back)
- Reconstruct jets with antiKT jets $R=0.5$ with different depths
 - Truth matching $\Delta R(\text{truth}, \text{reco}) < 0.2$
 - Truth jet p_T within 10% of parton jet p_T
- $\sim 12 \lambda$ needed to contain 20-40 TeV p_T jet

Single Pion E resolution

<https://arxiv.org/pdf/1604.01415v2.pdf>

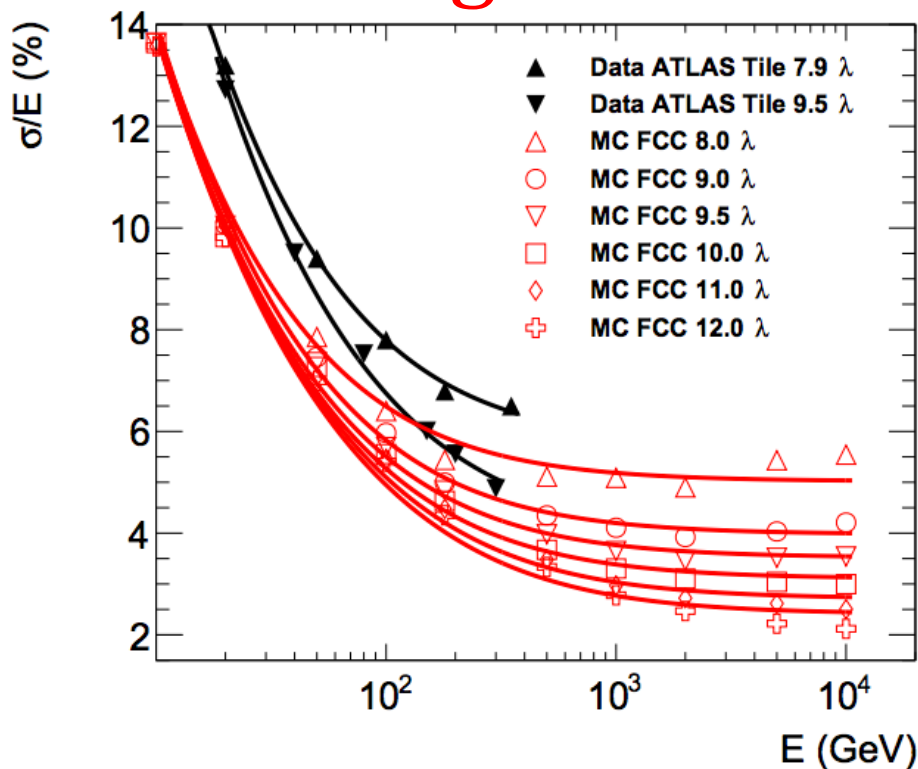

- MC more optimistic than data (in MC no noise, optics fluctuations, shorter showers)
- Improvement in data and MC at high E by increasing the calo depth
 - => reduce the constant term
- Energy resolution achievable
 - at 12 λ : $\sigma_E / E \sim 43\%/\sqrt{E} \oplus 2.4\%$

$$\frac{\sigma(E)}{E} = \frac{a}{\sqrt{E}} \oplus c$$

Depth (λ)	Simulation				Data	
	Sigma		RMS		Sigma	
	a (%GeV ^{1/2})	c (%)	a (%GeV ^{1/2})	c (%)	a (%GeV ^{1/2})	c (%)
8	41	5.0	42	6.9	52.9	5.7
9	43	4.0	43	5.3	-	-
9.5	43	3.5	44	4.5	54.5	4.0
10	43	3.1	45	4.0	-	-
11	43	2.7	45	3.4	-	-
12	43	2.4	45	2.9	-	-

Can get better hadron resolution at TeV range with calorimeters optimized for particle flow (PFA)?

<https://indico.cern.ch/event/438866/contributions/1085149/>

Software SiD (ILC) → Si FCC

Solenoid: 5T outside HCAL

Tracker: R=2m; 20-50 μm pixels

ECAL (Si/W): 2x2 cm. 32 layers

HCAL (Scint. / Fe):

- 5x5 cm cells
- 64 layers, 11.3 λ
- 3.1% sampling fraction (as Tilecal)

> 150 million cells, non-projective

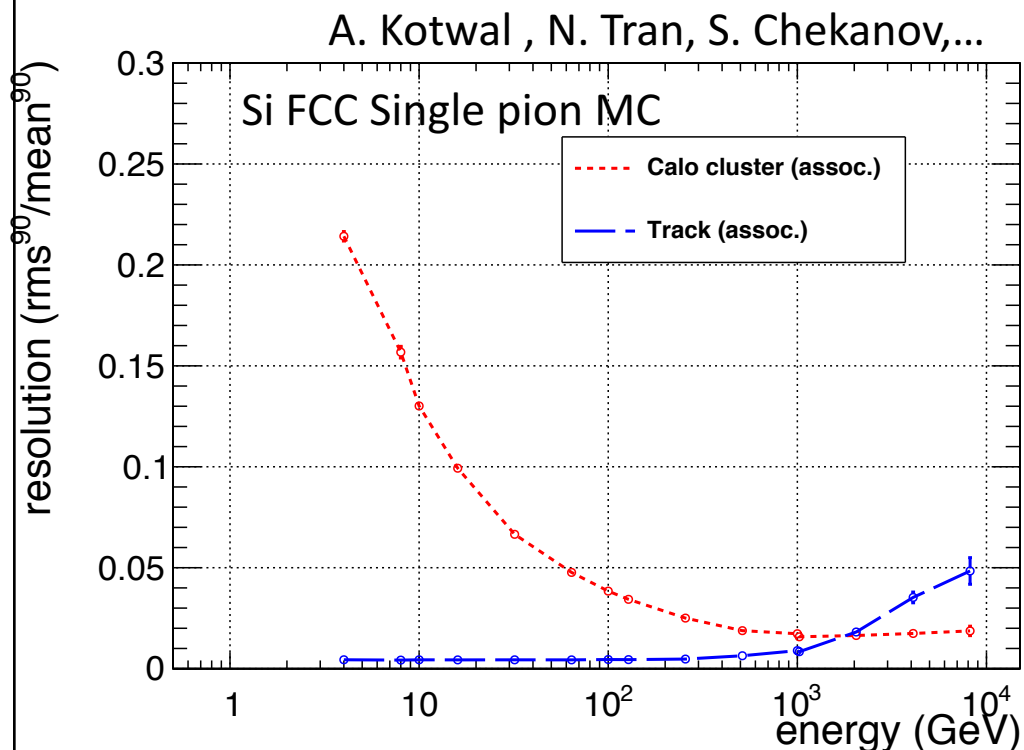

- Resolution of charged tracks & PFA gets worse with energy...
- Resolution of Calo Clusters better than PFA/tracks > ~1 TeV
- ~2% constant term for calorimeter clusters (as ATLAS-Tilecal)
- For jets PFA need to add neutral component and confusion term.

HCAL summary for FCC-hh

- **Requirements:**

- Depth of $\sim 12 \lambda$ (ECAL+HCAL) ; $\sim 10 \lambda$ HCAL alone
- Energy resolution constant term $\sim 2-3\%$ is needed
- $\Delta \eta \times \Delta \phi \leq 0.025 \times 0.025$
- Extended coverage up to $\eta \sim 6$ (with other/more radiation hard technologies)

- **Tile Calorimeter + Si-PMs**

- Good for the barrel and extended barrel HCAL ($45\%/\sqrt{E} \oplus 3\%$)
- Flexibility to improve granularity in η , ϕ , depth
- Implemented in the FCC-hh software as baseline for central HCAL
- Relatively cheap

Next steps for 2019 FCC-hh feasibility report

- Mature physics potential and detectors design/performance needs
- Due to huge cost of solenoid with 6T ; 6m radius



- Baseline detector solenoid \rightarrow 4T and 5 m radius
- Tile HCAL:
 - $R_{in} \sim 2.85\text{m}$; Active depth = 9.1λ ($\sim 11 \lambda$ active tracker+ecal+hcal)
 - Fe master plates 5 \rightarrow 7mm $\Rightarrow \lambda = 20.7 \text{ cm} \rightarrow \lambda = 19.9\text{cm}$)
 - Central barrel ($\sim 9\text{m}$ long) + ext. barrels ($\sim 3.5\text{m}$) up to $\eta < \sim 1.7$
 - Study standalone and combined performance with different ECAL options (Lar/Pb; Si/W;...) +tracker
 - HCAL longitudinal segmentation requirements
 -

3 FCC Detector layout (October 2016)

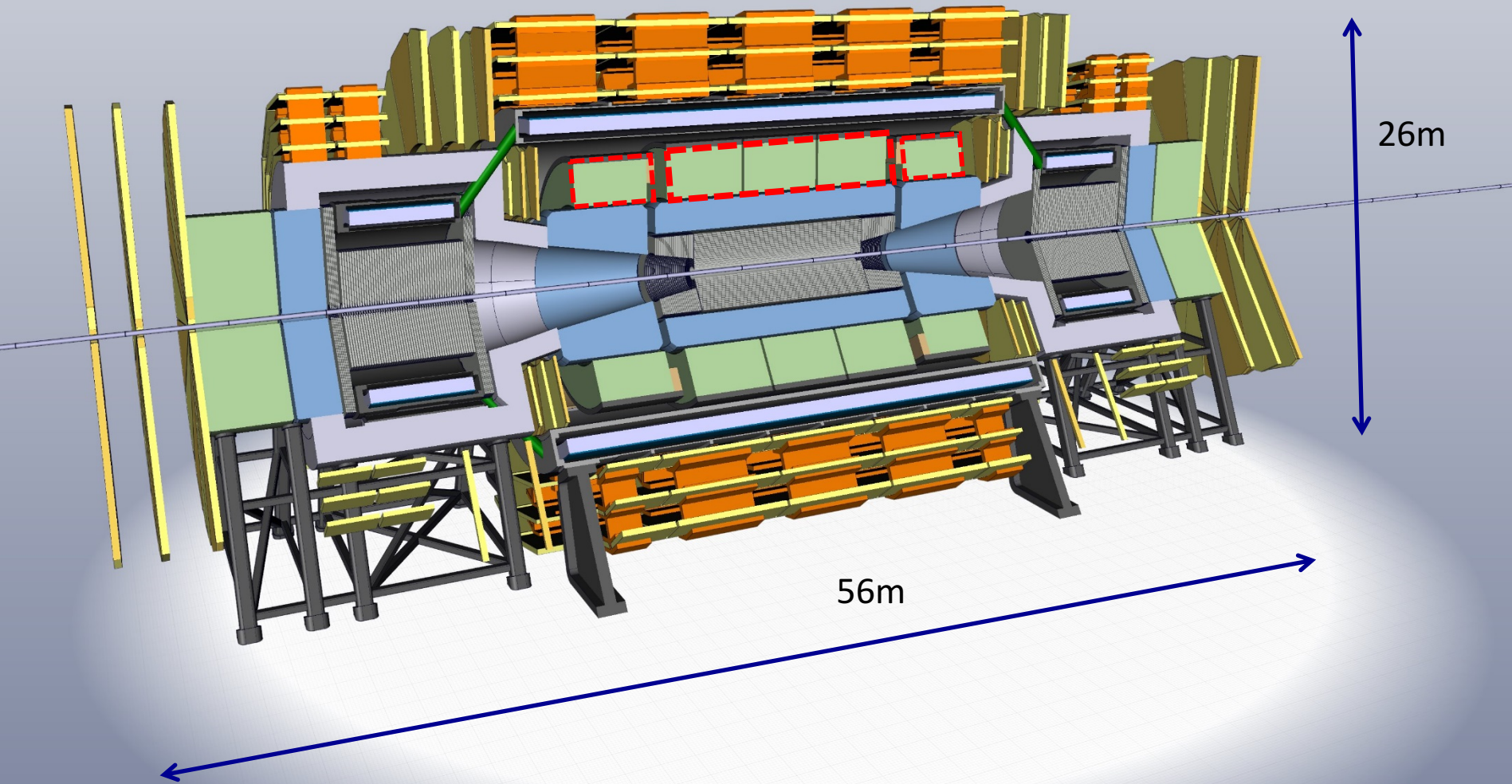

FCC-hh is a discovery machine and exciting project for HEP and CERN future

You are welcome to join!

Mailing list: *fcc-experiments-hadron@cern.ch*

To subscribe: <http://cern.ch/simba3/SelfSubscription.aspx?groupName=fcc-experiments-hadron>

And a lot of information at at the April 2016 Workshop in Rome:

<https://indico.cern.ch/event/438866/>

LAST MONTHLY MEETING LINK:

<https://indico.cern.ch/event/557689/>

The potential of multi-anode PMTs in ATLAS Tilecal for HL-LHC upgrades

Physics potential of ATLAS-Tile HCAL with better granularity

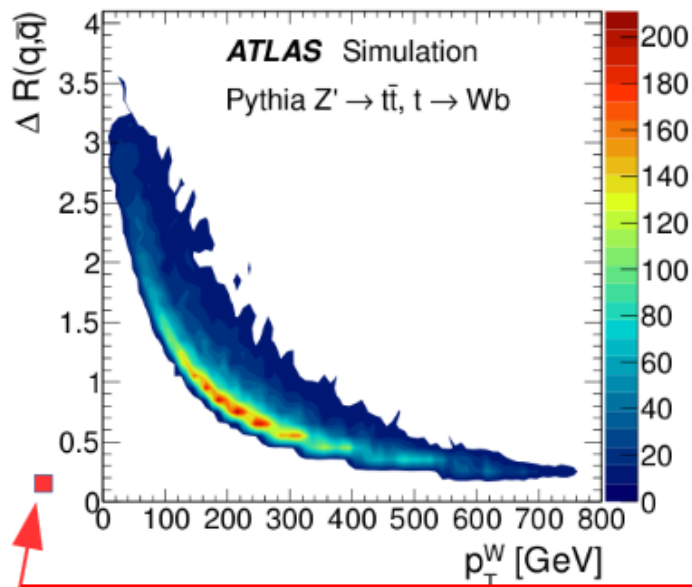

(b) $W \rightarrow q\bar{q}$

Boosted jets

- Higgs, W, Z, top ($p_T > 2$ TeV) decay to narrow jets with jet radius smaller than 0.4 in $\phi \times \eta$.
- Such narrow jets have substructure (2 or 3 subjets)

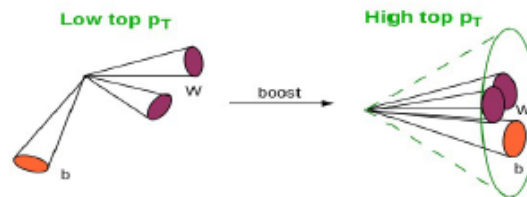

Present Tile cell size (0.1x0.1) is comparable with the typical Separation between two quarks from high Pt W decays

Neutral Long lived particles

Fraction of energy deposit in the middle HCAL layer vs NLLP decay point

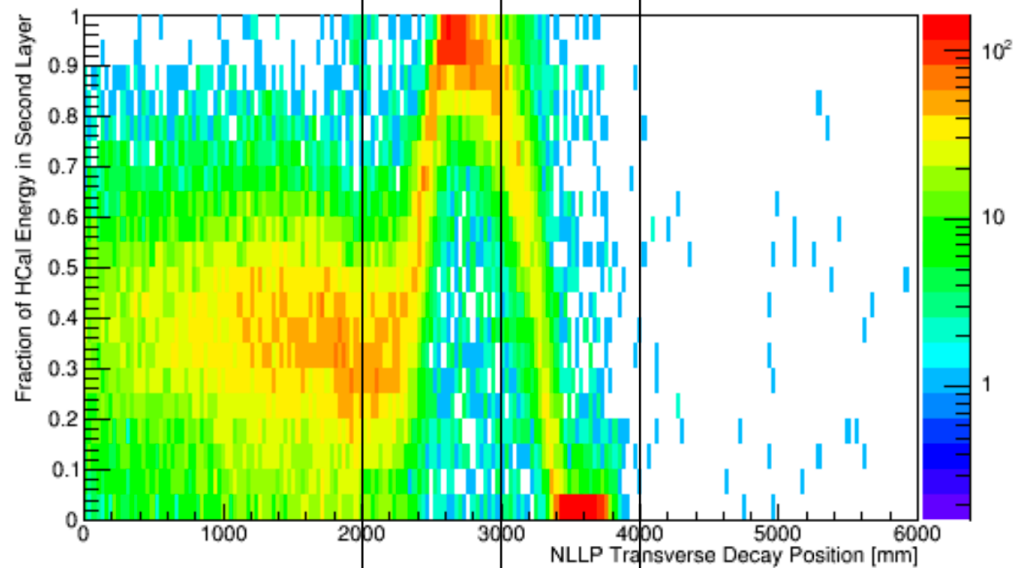
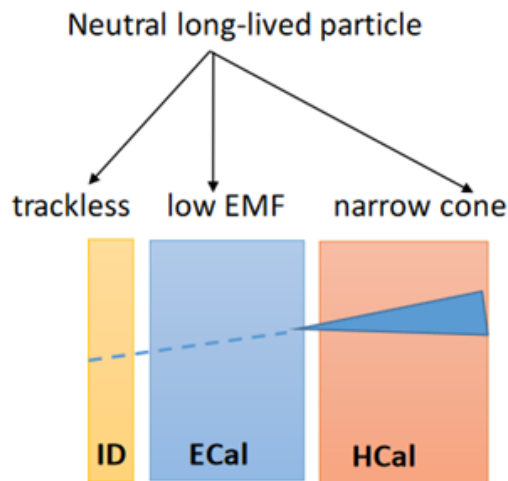

Increasing readout granularity for Tile Phase-II

- Scenarios under study for the barrel (jet performance, physics):
 - Inner most layer (A) η granularity ($\Delta\eta = 0.1 \rightarrow 0.025$)
 - 3->4 longitudinal layers=> Split BC layer (A = 1.5λ , B = 1.9λ , C = 2.3λ , D = 1.9λ)

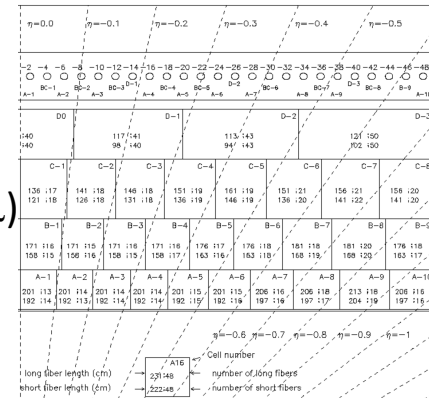

- Optics challenges:

- map individual fibers (randomly mixed in a bundle of $\sim 10\text{mm}$) onto the new 8×8 MAPMT
 - using cesium calibration as a “radiography” of the detector.
 - replace existing Light guide by a focusing lens or fibre light guide

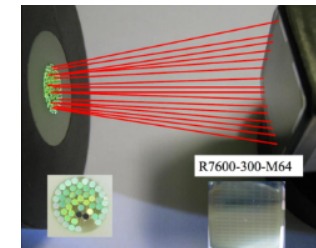

- Propose a new electronics layout, minimizing the impact on the current readout
- Aim for the Tile phase 2 Initial Design Report (end 2016) a chapter with preliminary motivation and first conceptual design for optics & electronics)
- Mature this proposal , hopefully to become the baseline for the September 2017 Technical Design Report

Impact in the Electronics phase 2 upgrade design being evaluated, with the crucial contribution by Christian Bohm

MANY THANKS!!!!

Response BC8 (Cs tube 4->9)

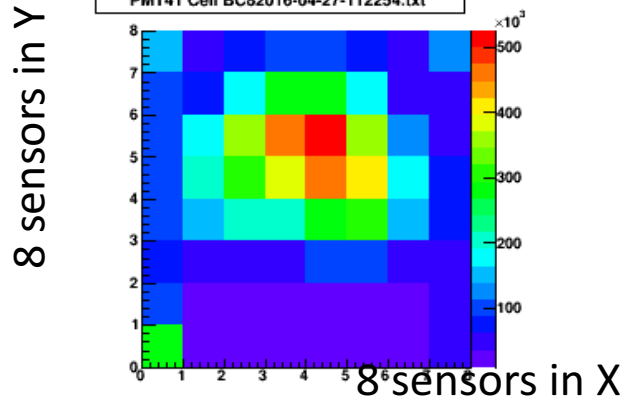

Very raw/preliminary Cs data in BC8 cell
(without removing yet cross talk between tubes nor sophisticated analysis)

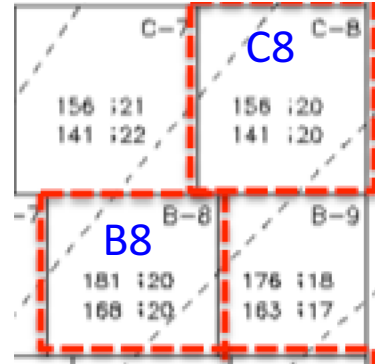

B8: Tile 4,5,6 and 2 fibres
C8: Tile 7,8,9 and 2 fibres

Response C8 (Cs tube 7->9)

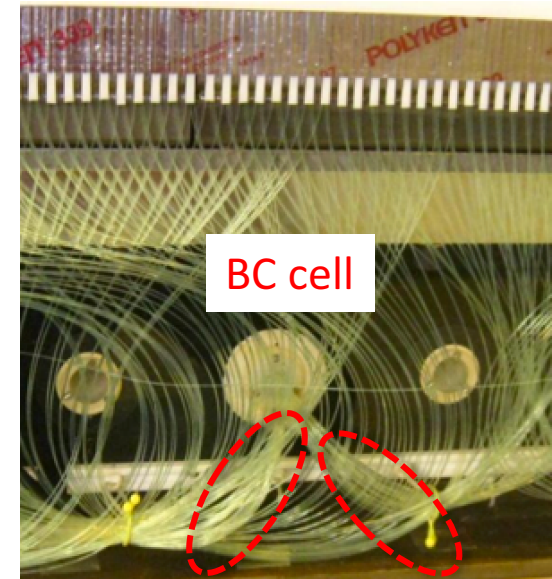
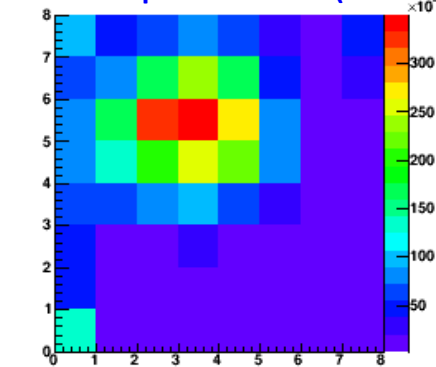

Response B8 (sum tube 4->6)

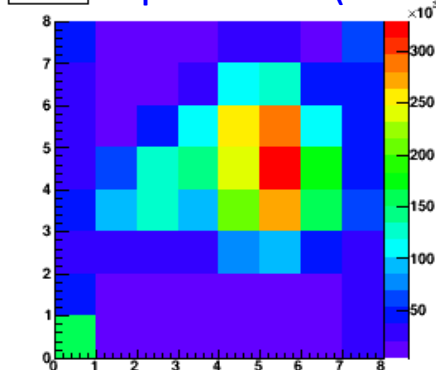

Preliminary non optimal tests/analysis confirm that the 2 groups of fibres reading B and C are located in ~ 2 regions in the fibre bundle and seen by different sensors-> facilitate the BC separation

Back-up

Impact on the readout electronics for Tile phase-II

- First studies started to define the requirements for higher granularity readout in terms of:
 - Bandwidth for digitized output transfer at 40 MHz from FEBs to the daughter boards
 - Power consumption
 - Constraint on mechanics and electrical interface with the hosting motherboard of each mini-drawer
- First item under study: possible modifications of the input stage of the proposed options for the Tile phase-II FEBs in case a multi-channel sensor will be selected.
- Evaluating two different approaches for handling up to 64 analog inputs to be summed for building the individual response of 2 or 4 sub-cells:
 - a) full configurable analog sums of signals from individual tiles in a tower layer.
 - b) Sum of all analog signal and pattern recognition and sub-cell association through discrimination versus a programmable threshold of each individual analog signal.
- Evaluating some existing ASIC chips (IN2P3/OMEGA program, LHCb CLARO chip) making analog sums and signal discrimination up to 64 channels.
- Roadmap to the IDR :
 - Refine the study of the constraints bounding the design of the modified electronics
 - Define a baseline architecture and reduce the alternative options (depending on the optics)
 - Prepare at least one conceptual design for the multi-channel sensor option
 - Define the R&D activities (with priorities) to be completed for the TDR

Using multi anode granular PMTs in LHC

- By LHCb at 40 MHz in RiCH
- <http://virgilio.mib.infn.it/~dperego/Publications/N41-171.pdf>
- <https://cds.cern.ch/record/2026401/files/Poster-2015-498.pdf>



RICH Upgrade

- New R/O: 64 channel multi-anode PMTs
- 40 MHz CLARO front-end ASIC



- By ATLAS alfa up to 10MHz

Proposal of multi-anode PMTs in Tilecal HL-LHC upgrades

OPTICS:

- Optimising interface fibre bundle-PMT :
“fibre light guide “ or “lens” or few mm air)
- Being done in lab (^{90}Sr) and modules (^{137}Cs)

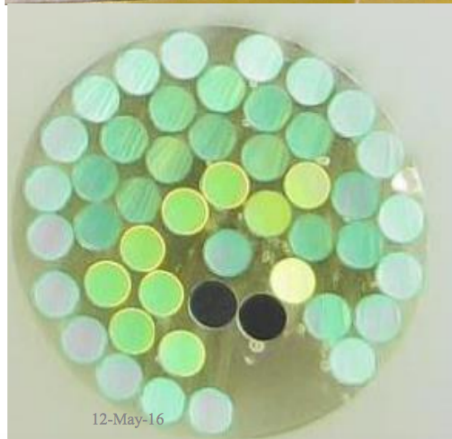
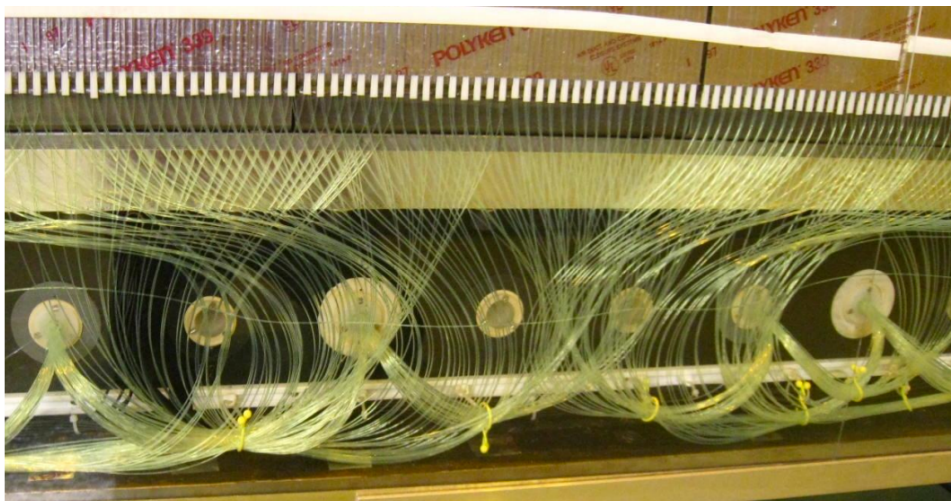

12-May-16

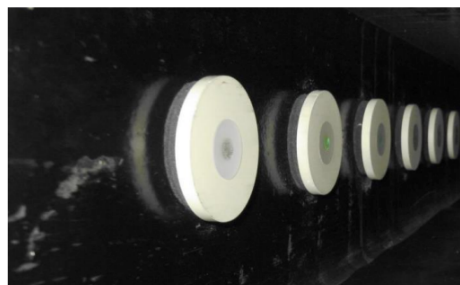

TileCal operation/maintenance 12/05

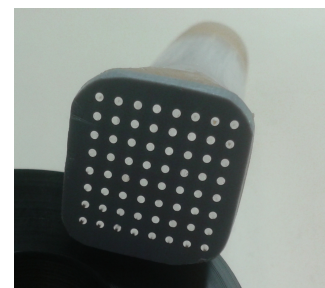
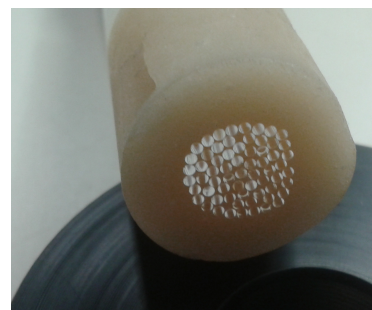
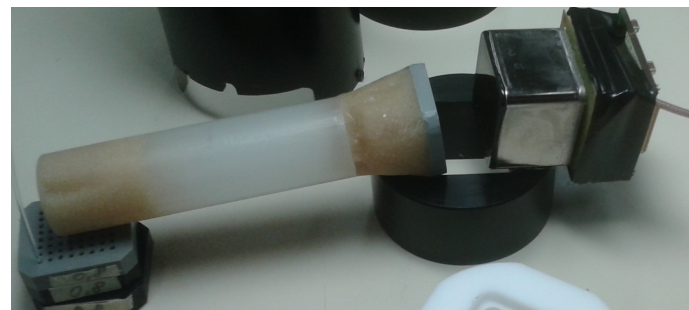
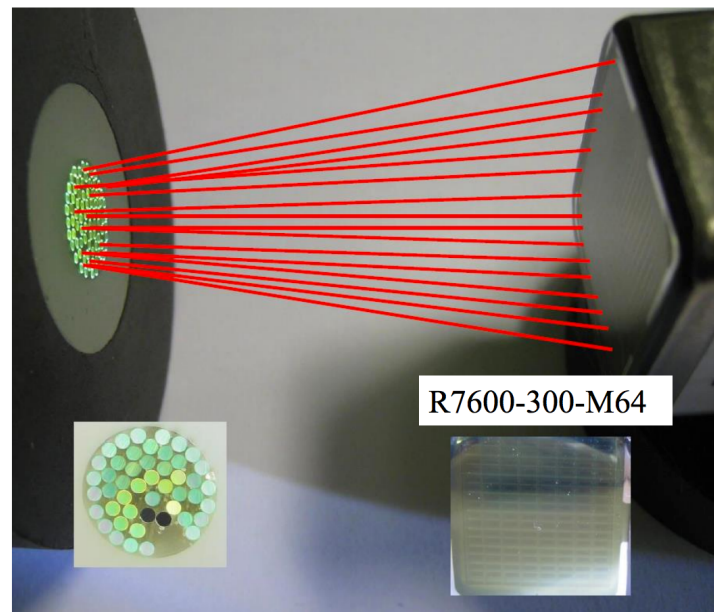

Passed the Cesium source in the BC8 and A10 cell tubes

Try to find which PMT sensors are excited when the Cs source excites a certain Tile volume

½ barrel cells layout

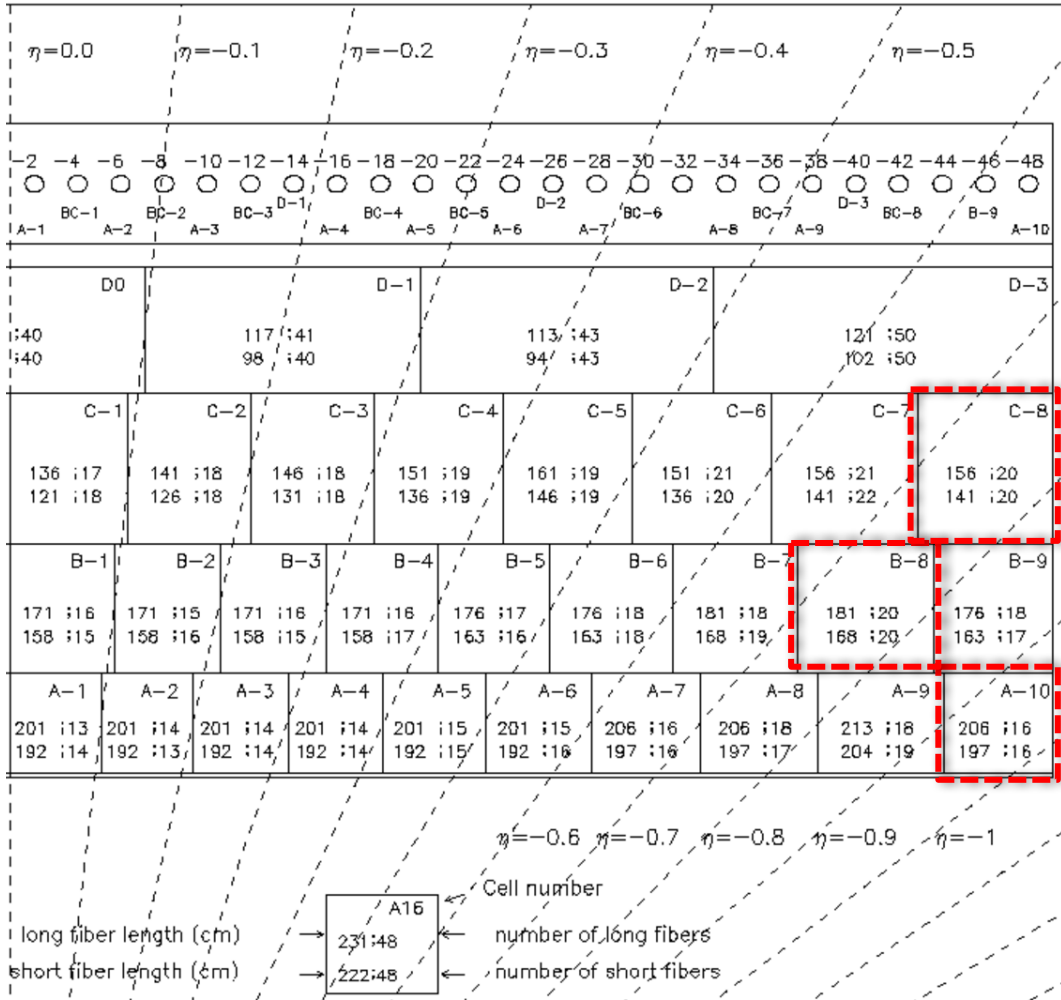

Experimental setup

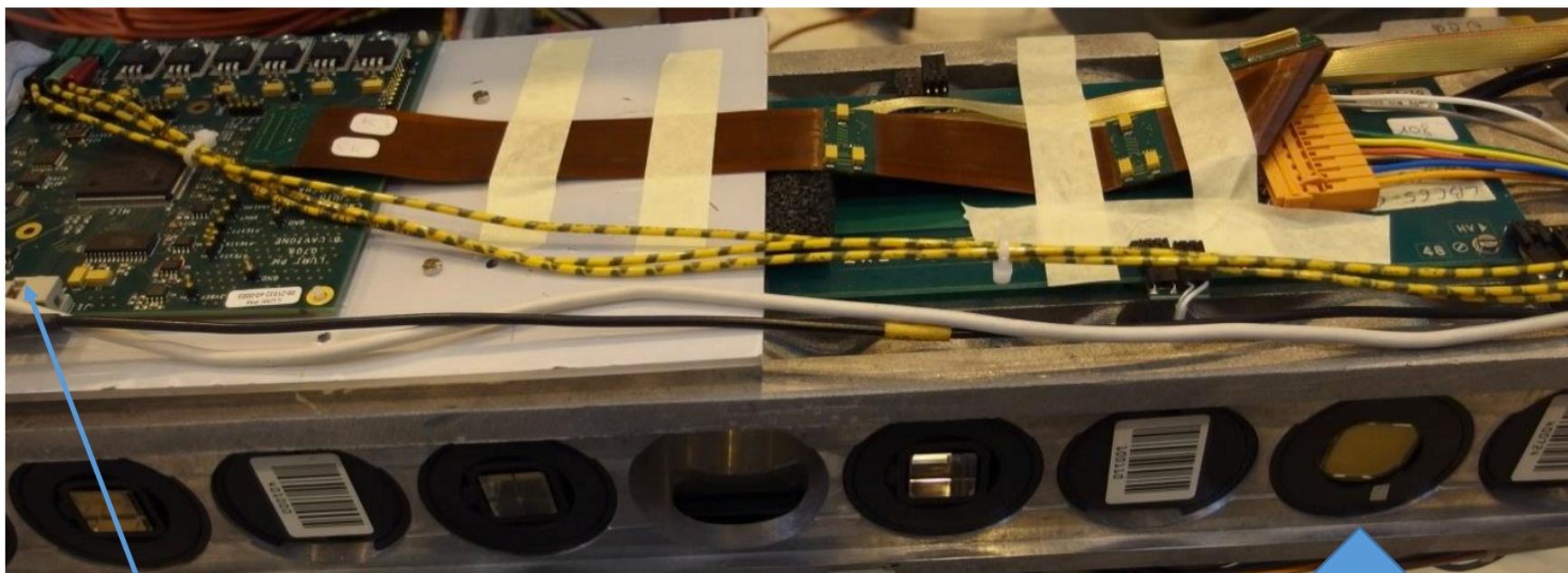

PMT#47==Cell A10

Hamamatsu R7600 MA PMT readout by MAROC chip connected to Orsay test board (borrowed from ALFA). MAPMT installed in the LBC65 drawer instead of the usual PMT.

MAROC readout

Fast shaping, not synchronized with Cs events.

The signal was sampled at the time of the external trigger – run from a generator approx. every millisecond.

All 64 channels were digitized at the trigger time and read out.

Pedestals were subtracted. The low level noise was suppressed by cut.

The readout is not optimal for Cs setup and the results could be improved by the proper readout with signal integration.

Attempt was made to implement direct signal integration readout, but the available multichannel integrators (CAEN 792) are not sensitive enough.

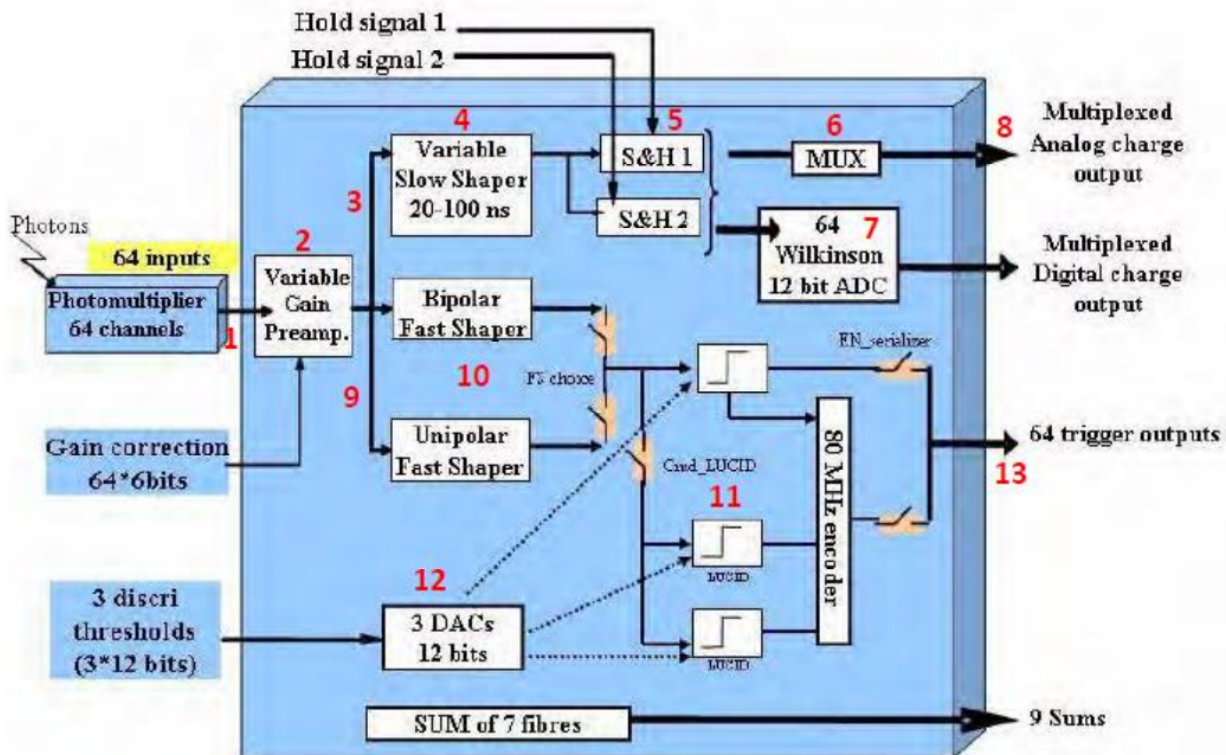
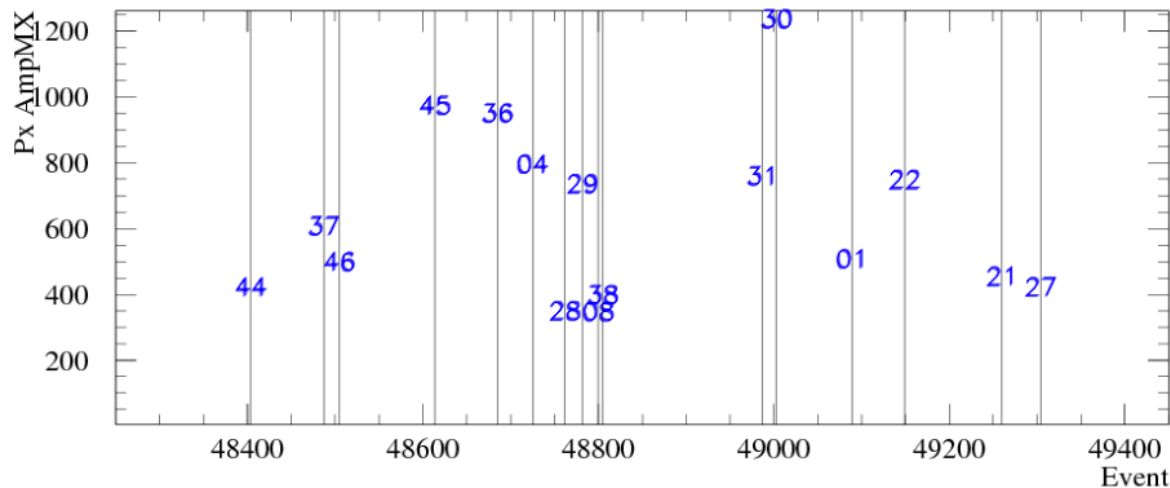
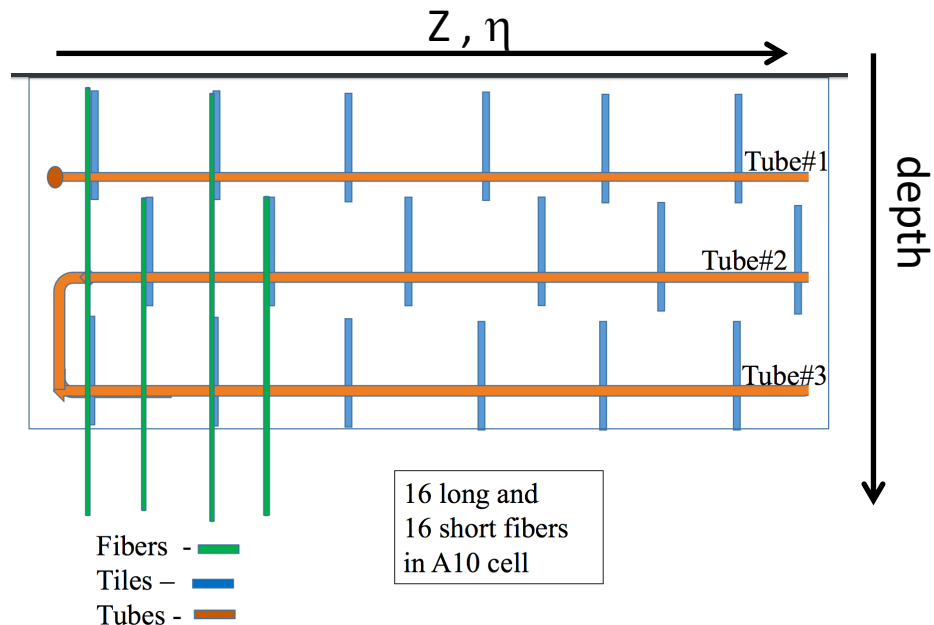
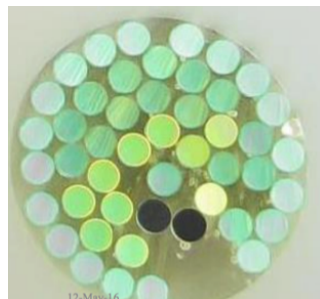

Figure 14.6. *LEFT*: MAPMT with full PMF mounted: MAPMT + isolator + spacer + voltage divider + spacer + isolator + passive board + active board. *RIGHT*: The layout of the MAROC 2. The figure is figure 3 in [58]. The red numbers are added to the figure.

From Sune Jakobsen PhD thesis
(ATLAS ALFA detector)

Very raw/preliminary Cs data in A10 cell tube 3 (16 tiles)

- 32 (16x2) fibres
- 48 (16x3) tiles
- Long fibre read tile #1,3
- Short fibre read tile #2



Time of maximal response from pixel #N

Able to identify the 16 tiles in tube 3

The same BC8 cell in 2 Cs scans , changing the PMT alignment, touching the coupling PMT-fibre bundle (very sensitive to set-up, alignment and with this non optimised set-up)

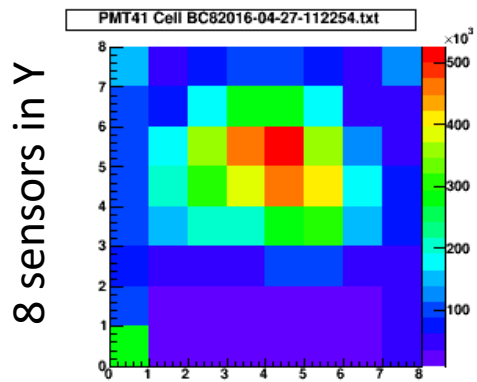

Response BC8 (Cs tube 4->9)

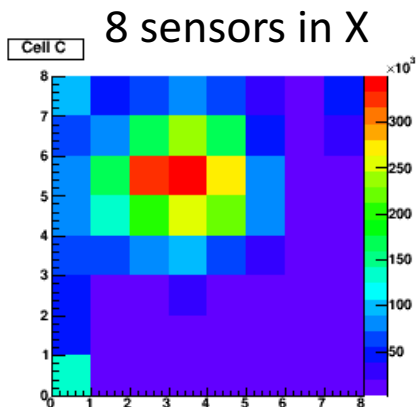
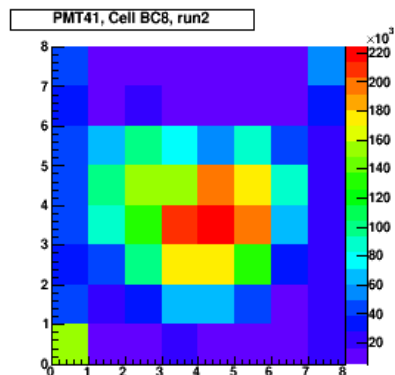

Response C8 (Cs tube 7->9)

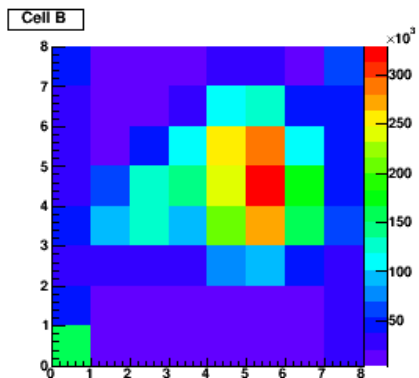
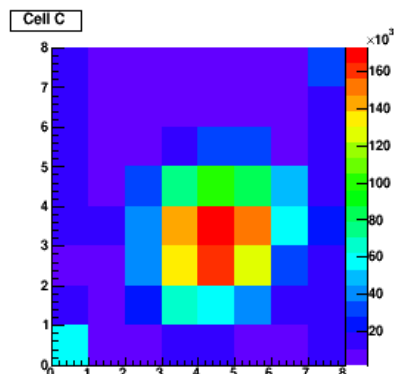

Response B8 (sum tube 4->6)

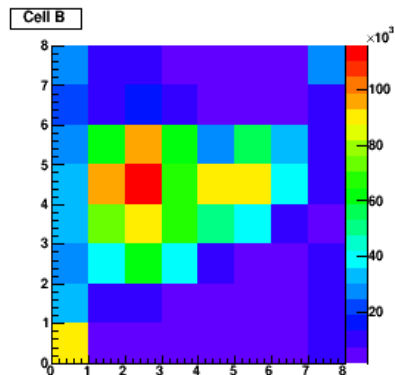

ATLAS upgrade Simulation working group

- atlas-tile-simulation-upgrade@cern.ch
- coordinated by S. Chekanov (ANL) and P. Starovoitov (KIP)
- bi-weekly meetings on Mondays 5pm CET
- Recent meeting agenda : <https://indico.cern.ch/event/539617/>
- For the moment concentrate on the granularity project: Jana, Sasha, Pavel
- Aim to study the potential gain of Tile granularity on the jet/Etmiss performance, jet-substructure, long lived particles, L1 calo perf. , with the participation of the respective ATLAS groups
- In future: simulations for QIE, methods of dealing with pileup, occupancy studies, etc...

π resolution in test beams \rightarrow jet resolution in ATLAS

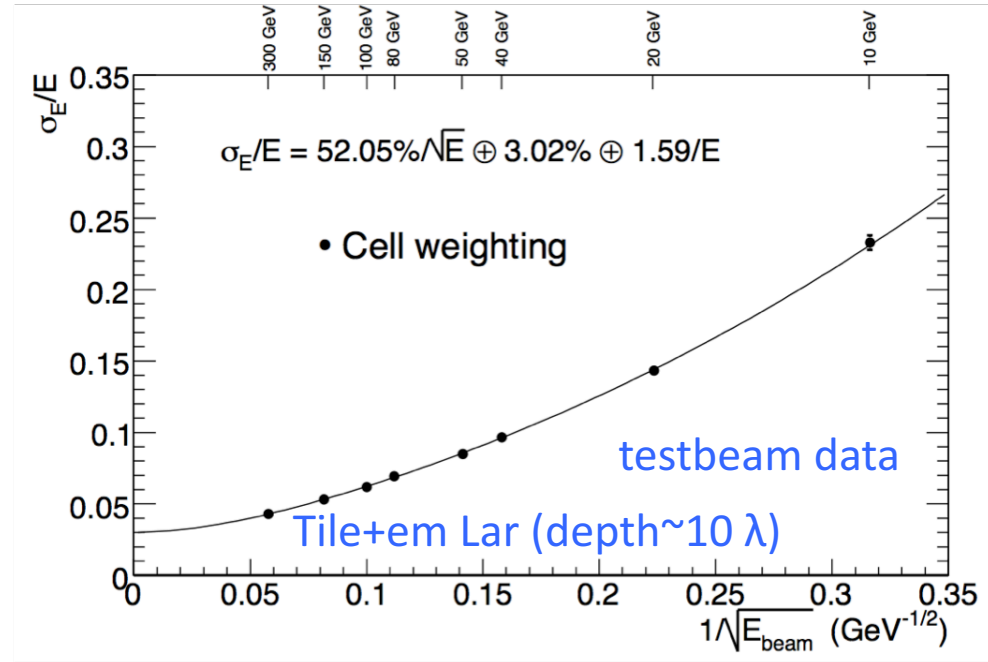
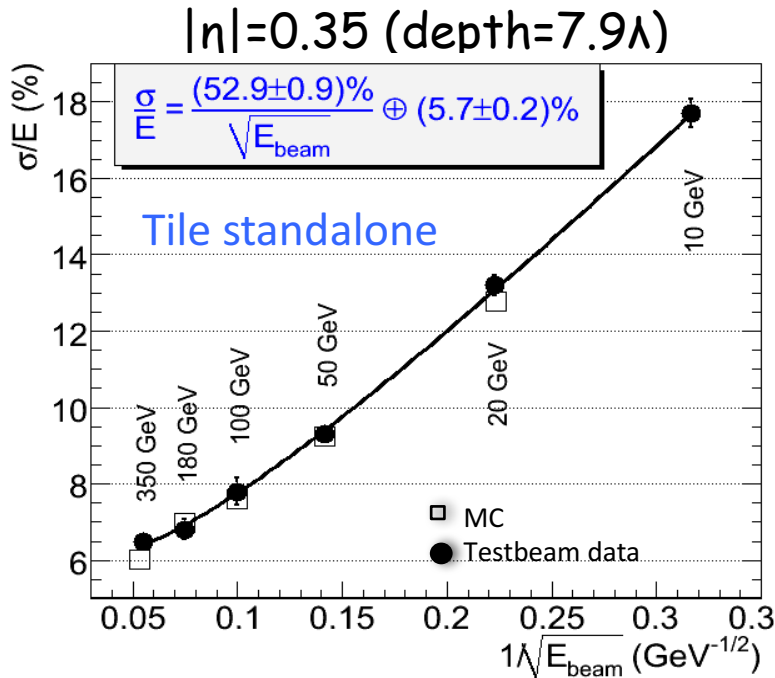

Good performance thanks to >10 years R&D, test-beams, MC tuning, cosmics

Jet resolution close to design:

- constant term $\sim 3\%$
- Pile-up worsen low p_T resolution
- Improvements after pile-up corrections for in-time/out-time bunches/noise threshold tuning, etc.

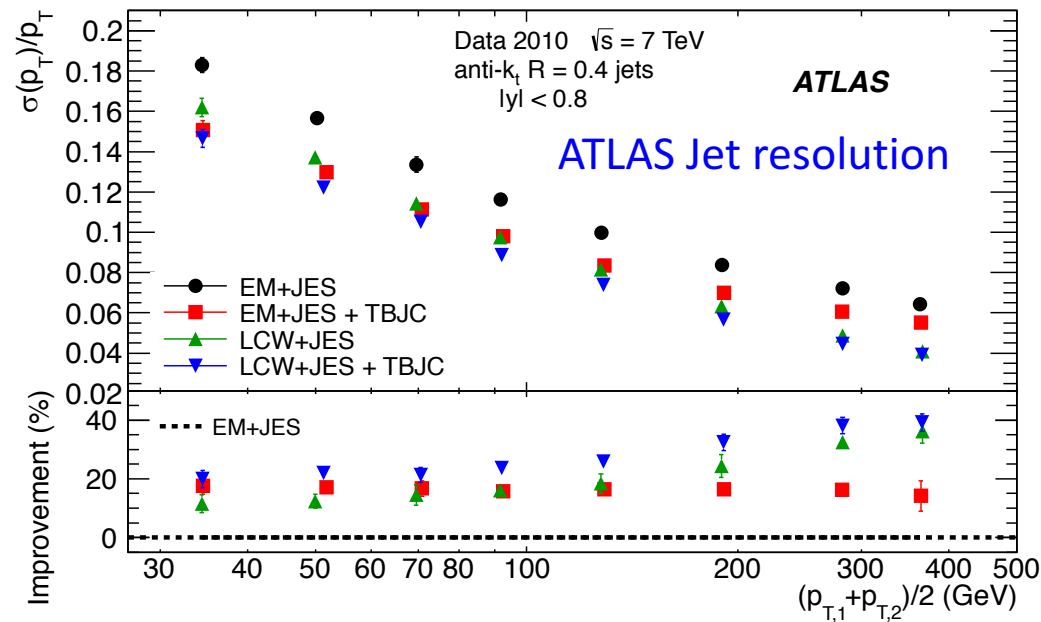

SiPM Cell size vs Radiation Damage

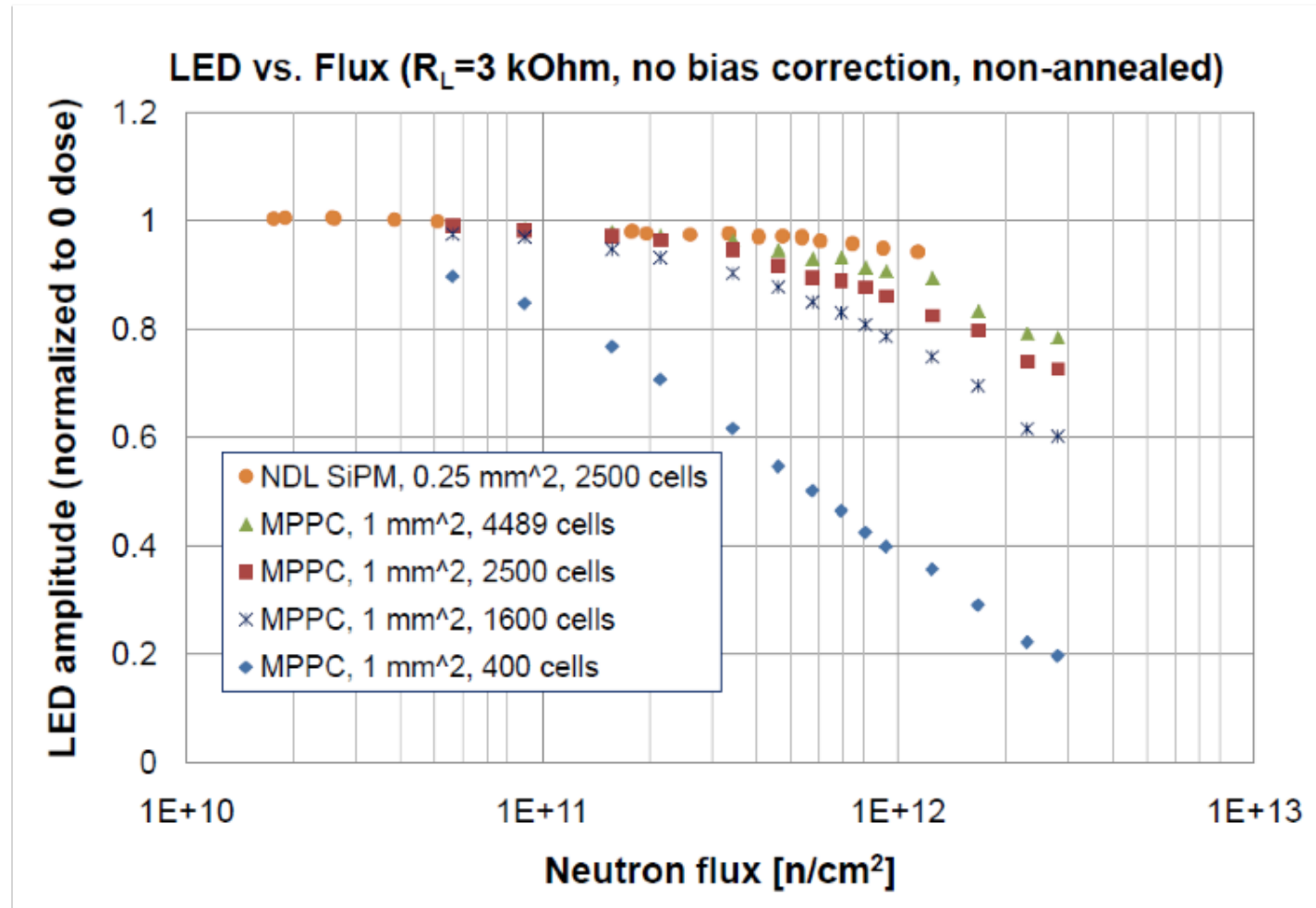

ATLAS Tile calorimeter characteristics

Characteristics	ATLAS $ \eta < 1.7$
Absorber	Steel
Absorber/scintillator ratio	4.7:1
Geometry	Tiles & fibres \perp to pp beam axis
Tiles-Fe periodicity in Z	18 mm (3mm Tiles+14mm Fe)
Tiles characteristics: - Tile dimensions ($\eta \times \phi \times R$): - Inner radius - Outer radius - WLS Fibres	Polystyrene+1.5%PTP+0.04%POPOP by injection molding, no grooves ; ~ 70 tons 11 trapezoidal sizes in depth/R ; ~ 40105 tiles 3 mm x ~22 cm x ~10 cm ; 3 mm x ~35 cm x ~19 cm Kurary Y11 ; 1mm diameter ; ~1062 Km ; ~620 000 fibres
3 cylinders (Barrel+2 Ext B): Length in Z Outer radius(w/supports+elect.) Outer active radius Inner active radius Active depth ΔR at $\eta=0$ Volume (inner-outer active R) Weight	12m 4.2 m 3.9 m 2.3 m 1.6m; 7.7λ 372m ³ 2900 T
Longitudinal Segmentation	3 layers
Transversal granularity ($\Delta\eta \times \Delta\phi$)	0.1x0.1 inner and middle layers ; 0.2x0.1 outer layer
# channels/PMTs	10 000 channels
Gain-dynamic range	10^5 ; 2 gain 10 bits ADCs
X_0 ; λ_p ; Moliere Radius	22.4 mm ; 20.7 cm ; 20.5 mm

ATLAS Tile calorimeter Performance

Characteristics	ATLAS $ \eta < 1.7$
Light yield	70 phe/GeV
σ_E/E (tbeam standalone)	52%/√E+ 5.7% (7.7 λ) 45%/√E+2 % (if 9.2 λ)
Jet resolution target	~50-60%/√E ⊕ 3%
e/h	1.33
em sampling fraction	3%
Max dose at HL LHC (3000 fb-1)	0.2Mard
Max light reduction due to irradiation in run1	-2%
Max. light reduction expected at HL LHC	-15%

Machine parameters

parameter	LHC	HL-LHC	FCC-hh
c.m. energy [TeV]		14	100
dipole magnet field [T]		8.33	16 (20)
circumference [km]		26.7	100 (83)
luminosity [$10^{34} \text{ cm}^{-2}\text{s}^{-1}$]	1	5	5 [$\rightarrow 20?$] (*)
bunch spacing [ns]		25	25 {5}
events / bunch crossing	27	135	170 {34}
bunch population [10^{11}]	1.15	2.2	1 {0.2}
norm. transverse emitt. [μm]	3.75	2.5	2.2 {0.44}
IP beta-function [m]	0.55	0.15	1.1
IP beam size [μm]	16.7	7.1	6.8 {3}
synchrotron rad. [W/m/aperture]	0.17	0.33	28 (44)
critical energy [keV]		0.044	4.3 (5.5)
total syn.rad. power [MW]	0.0072	0.0146	4.8 (5.8)
longitudinal damping time [h]		12.9	0.54 (0.32)

(*) Inst. Luminosity $5 \times 10^{34} \rightarrow \sim 20\text{-}30 \times 10^{34} \text{ cm}^{-2}\text{s}^{-1}$ in a second phase

23/01/15

The FCC-hh project

48

Baseline Geometry used up to now , Twin Solenoid, 6T, 12m bore, 10Tm dipole

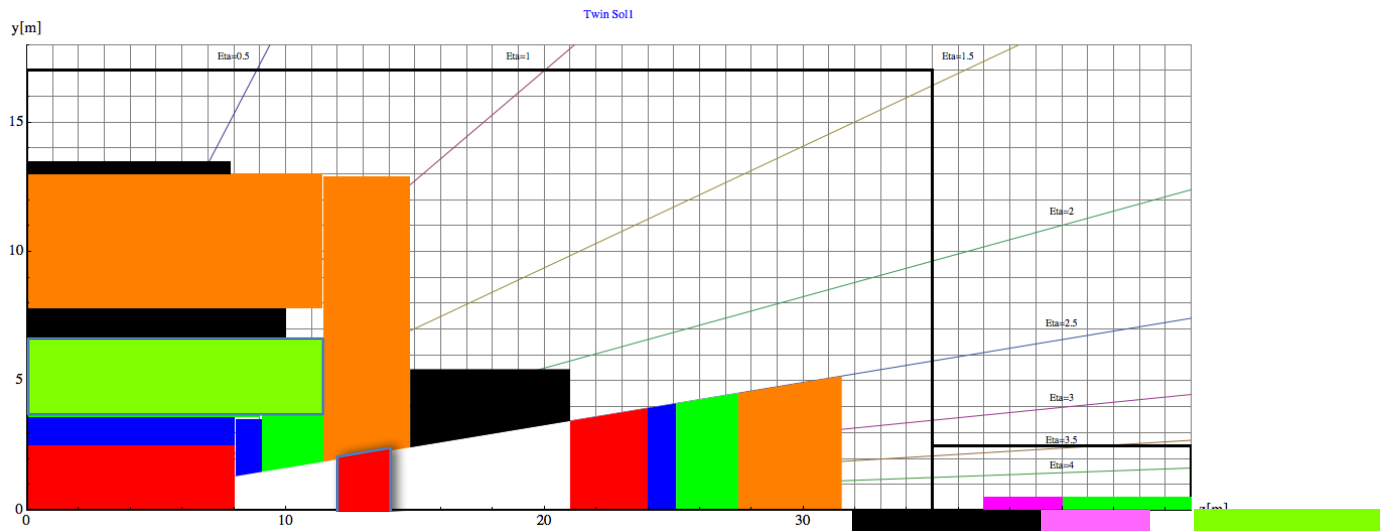

Barrel:

Tracker available space:
R=2.1cm to R=2.5m, L=8m

EMCAL available space:
R=2.5m to R= 3.6m → dR= 1.1m

HCAL available space:
R= 3.6m to R=6.0m → dR=2.4m

Coil+Cryostat:
R= 6m to R= 7.825 → dR = 1.575m, L=10.1m

Muon available space:
R= 7.825m to R= 13m → dR = 5.175m
Revision of outer radius is ongoing.

Coil2:
R=13m to R=13.47m → dR=0.475m, L=7.6m

Endcap:

EMCAL available space:
z=8m to z= 9.1m → dz= 1.1m

HCAL available space:
z= 9.1m to z=11.5m → dz=2.4m

Muon available space:
z= 11.5m to z= 14.8m → dz = 3.3m

Forward:

Dipole:
z= 14.8m to z= 21m → dz=6.2m

FTracker available space:
z=21m to R=24m, L=3m

FEMCAL available space:
Z=24m to z= 25.1m → dz= 1.1m

FHCAL available space:
z= 25.1m to z=27.5m → dz=2.4m

FMuon available space:
z= 27.5m to z=31.5m → dz=4m

Tracking Resolution for Dipole and Solenoid

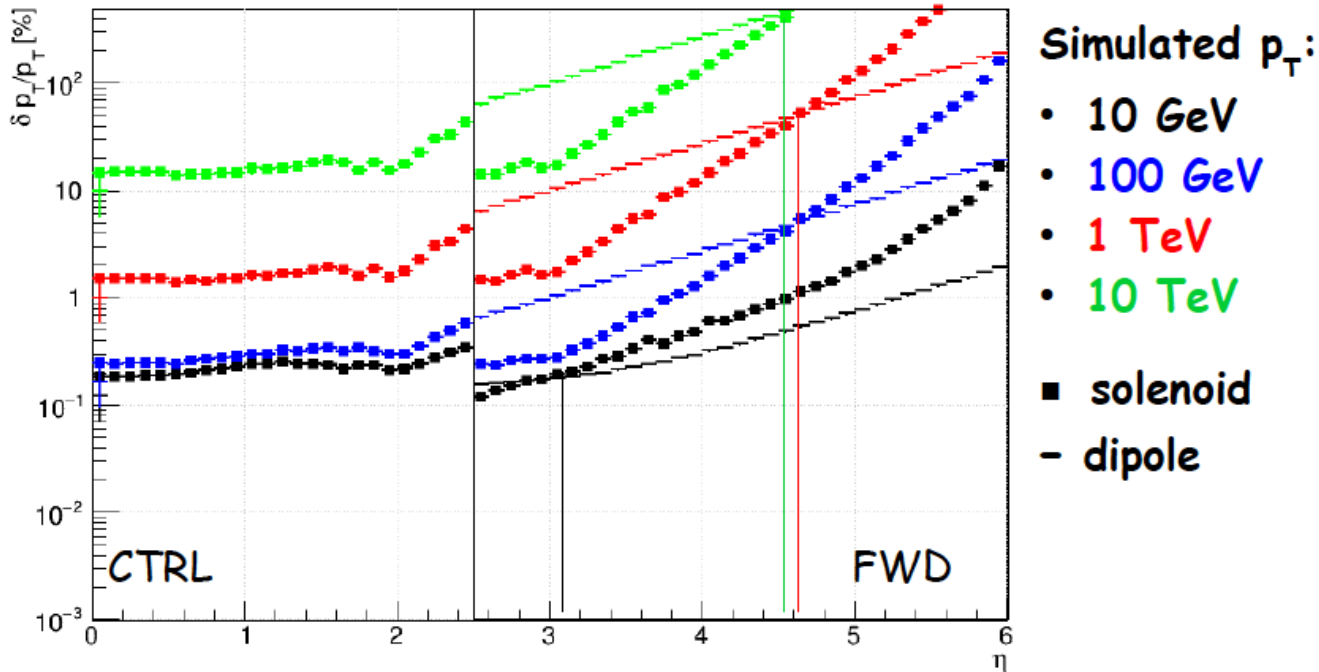
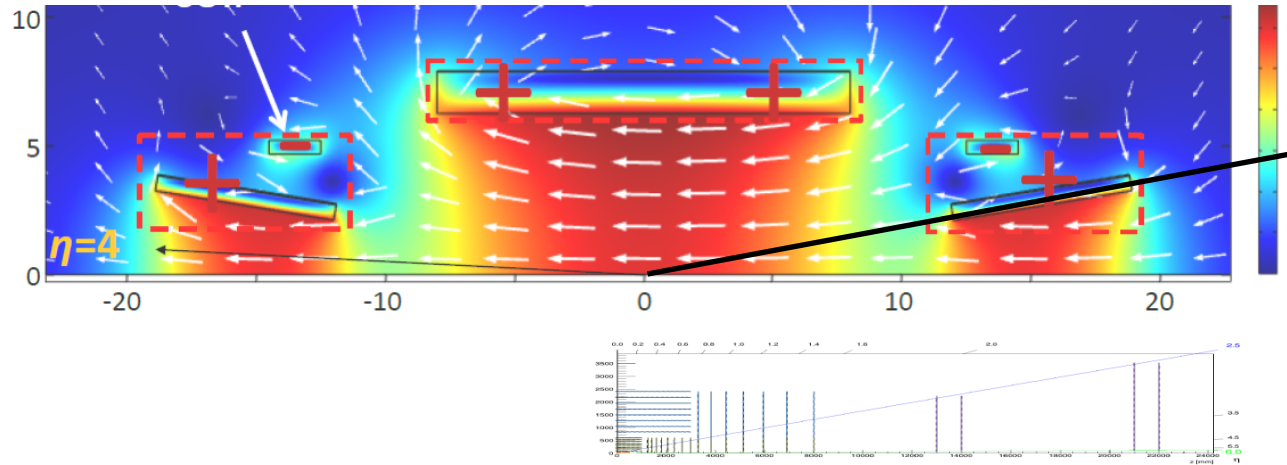

Status of the Software Project

- Aim of the Software Project is to **support all of hh/ee/eh studies**
 - Need to support multiple detectors in simulation and reconstruction
 - Need to support simulation in different levels of details
- Since FCC Week 2015 plenty of work finished
 - Most of the progress up to our highly motivated students!
- Simulation
 - **Delphes** integrated and **ready to use**
 - Technical infrastructure for combined **fast/full simulation with Geant4** in place
- Reconstruction
 - Joint project with ATLAS to apply their track reconstruction software (**ACTS**)
 - **PAPAS** for fast simulation and particle-flow reconstruction
- Analysis
 - Standalone reader for FCC data model
 - **Heppy** as python-based analysis framework
 - Both can be installed on your laptop!
- **For details see other presentations in this session**

FCC Software in the HEP SW Landscape

$H, A \rightarrow \tau\tau \rightarrow \text{two } \tau \text{ jets} + X, 60 \text{ fb}^{-1}$

- We do not have resources to do everything by ourselves
 - Whenever there is something (almost) ready to use \Rightarrow take advantage of the work others do!
- Our software is based on the following external software
 - **Gaudi** as underlying framework
 - **Delphes** for parameterized simulation
 - **Geant4** for simulation
 - **DD4hep** for detector description
- Collaborating with
 - **ATLAS** on tracking
 - **CMS** on analysis interface
 - **LHCb** on simulation framework and infrastructure
 - **CLIC** on grid processing (planned)
 - **Surprisingly successful cooperation within HEP SW community**
- We are as well contributing to the HEP Software with our additions
 - **Heppy** and **PAPAS** as integrated Python-solution
 - **PODIO** for data models

Cavern dimensions

Detector envelop: 56 x 26 x 26 m³

Size cavern: 70 x 30 x 35 m³

Diameter shafts: 15 m and 9 m

Large shaft maximum load: 2 kt

Small shaft maximum load: 0.25 kt

